

DOCUMENT RESUME

ED 102 714

EA 006 835

AUTHOR Myers, Spencer W.
TITLE The Future Management of Education: A Design for Its Improvement.
INSTITUTION Foundation for Minnesota Progress, St. Paul.
PUB DATE 74
NOTE 121p.
AVAILABLE FROM Foundation for Minnesota Progress, Hanover Building, 480 Cedar Street, St. Paul, Minnesota 55101 (\$2.50)

EDRS PRICE MF-\$0.76 HC-\$5.70 PLUS POSTAGE
DESCRIPTORS Accountability; Behavioral Objectives; Budgeting; *Delivery Systems; *Educational Administration; Educational Objectives; Evaluation; *Learning Theories; Management Information Systems; *Management Systems; Objectives; *Organization; Systems Approach

ABSTRACT

This report explains the application of management system principles to education. The principles include (1) a statement of the major mission of the organization, (2) statements of goals and objectives, (3) a definition of the product and an identification of the factors essential to the production of the product, (4) a description of the delivery system, (5) an outline of the organizational structure including job descriptions, (6) an accounting of productivity, and (7) a data-based communications system for problem-solving and reporting. It is suggested that these related system components will result in greater productivity and efficiency, more effectiveness in quality, greater understanding, and more support that leads to individualized learning. (Author/DW)

ED102714

CORRECTIONS

p. 19
p. 6f
p. 69
p. 87

U.S. DEPARTMENT OF HEALTH,
EDUCATION & WELFARE
NATIONAL INSTITUTE OF
EDUCATION

THIS DOCUMENT HAS BEEN REPRODUCED EXACTLY AS RECEIVED FROM THE PERSON OR ORGANIZATION ORIGINATING IT. POINTS OF VIEW OR OPINIONS STATED DO NOT NECESSARILY REPRESENT OFFICIAL NATIONAL INSTITUTE OF EDUCATION POSITION OR POLICY.

"PERMISSION TO REPRODUCE THIS COPYRIGHTED MATERIAL HAS BEEN GRANTED BY

*Foundation for
Minnesota Progress*

TO ERIC AND ORGANIZATIONS OPERATING UNDER AGREEMENTS WITH THE NATIONAL INSTITUTE OF EDUCATION. FURTHER REPRODUCTION OUTSIDE THE ERIC SYSTEM REQUIRES PERMISSION OF THE COPYRIGHT OWNER."

THE FUTURE MANAGEMENT OF EDUCATION

A Design for Its Improvement

Foundation for Minnesota Progress

"All education springs from images of the future and all education creates images of the future."

Alvin Toffler

EA 006 835

LETTER OF TRANSMITTAL

To all those who are interested in the future of education:

Two years ago a small group of Minnesotans, lay and professional, decided to come to grips with the basic question of whether public education might be more effectively managed in order to more surely achieve desired results.

This report brings together under one cover what that inquiry has produced to date.

The motive for making this the first (and so far, the only) project of the Foundation for Minnesota Progress was to find ways, if possible, for education to move more rapidly to the high goal of truly individualized learning.

Along that route, if it could be followed by the whole education establishment, would be another most fruitful result -- a far more rational method of arriving at priorities for the allocation of ever-scarce resources.

It was the reasoned conviction of the Foundation's board and of its consultant Dr. Spencer Myers, that management tools well proven in other sorts of human endeavor are fully within reach of educators. There was a hope that if more people within the education establishment were to become excited about picking up such tools and using them, the changes that could result would be rewarding indeed.

Most importantly, these rewards could accrue to a generation of students whose individual learning requirements would for the first time become the system-wide objective.

We believe we are presenting here one example of an organized, definitive, logical structure for a management system for education.

All the parts of the system relate to one another, and should result in greater productivity and efficiency, more effectiveness in terms of quality, greater understanding and more support.

Also included in this report is a reflection of the dialogue which has taken place about the idea of a management system in education. The project succeeded in bringing together representative delegations from the various interest areas -- citizen groups, teachers, administrators, school boards, etc. -- in several regional workshops. Typical questions and responses are here as an appendix.

The concept was examined in many hours of state legislative committee hearings, in pursuit of the question as to how to assign resources to the development of educational management skills and systems.

A special finance task force of the Minnesota State Department of Education concluded its biennium of work in mid-1974 by recom-

mending a management system approach, and the essence of this study is also included here as an appendix.

The Foundation board asked Dr. Myers to put this report together, organizing it under the seven-point outline of what we identify as the logical elements of a management system.

This he has done, and the report is his work, incorporating the many inputs from the 20 months of dialogue the Foundation has stimulated. The reader will find one chapter devoted to each of the seven elements, including hypotheses which if tested will help determine if (a) a management system is workable, and (b) if this particular outline is the optimum one.

This is, i.e., a working document.

The Foundation's directors offer it as a sound contribution towards accountability in education, and express sincere appreciation to those firms whose financial support has enabled this work to be done.



Ron Kennedy
President, Foundation for
Minnesota Progress

Foundation for Minnesota Progress

Mailing address:

Hanover Building
480 Cedar Street
St. Paul, Minnesota 55101

Telephone contact:

Ron Kennedy
Foundation President
(612) 370-7611

by

Dr. Spencer W. Myers
Executive Director
Foundation for Minnesota Progress

Teacher

Principal

Director of Instruction

Superintendent of Schools

Innovator

College and University Instructor
in School Management

Clinic and Conference Conductor
in Management Systems

Believer in Education

TABLE OF CONTENTS

Chapter		Page
I	Introducing a Management System	1
II	The Major Mission of Education	9
III	Goals and Objectives	11
IV	Managing Learning	19
V	The Delivery System	34
VI	Organization Structure	51
VII	Budget: Cost and Income	77
VIII	Communications	89
IX	The Expected Results	93
Appendix A	Improving Minnesota Education - An Introduction to Management Systems	97
Appendix B	Issue Paper - Education Management System	107
Appendix C	Members of the Board of Directors 1974	115
	Financial Sponsors of the Education Project	116

CHAPTER I

INTRODUCING A MANAGEMENT SYSTEM

The idea of management as a science began in the 1880's and 1890's in France. In the United States Taylor and others developed the idea beginning in the early 1900's. Most of the management development related to commercial and industrial enterprises with some small development in the military establishment. Very little developed in the public service sector until quite late; most developments in education came well after the conclusion of World War II. The evolution of the educational process was very slow, developing essentially from the monastic and rural classroom. Even urban systems currently find their structure to be essentially multiples of such classrooms. It would be proper to say that ideas concerning major staff specialization and learning productivity are just beginning to evolve.

In the meantime, costs have increased five times or more since World War II; the change from increasing enrollment to decreasing enrollment with continually accelerating cost, has merely intensified the problem. We believe it would be appropriate here to let others speak to the problem in the items that follow:

Item

Daniel Patrick Moynihan, former Professor of Education and Urban Politics at Harvard and presently Ambassador to India:

"Further analysis proves James Coleman right in concluding in 1966 that school spending appears to have little to do with how well students learn. School expenditures -- equal or unequal -- seem to (have) so little effect as for practical purpose to be naught."

The Moynihan re-analysis diminishes further the notion that school inputs such as per pupil expenditure have any significant influence on educational outputs.

Item

Peter F. Drucker, probably the world's best known management specialist, in his book, The Age of Discontinuity:

"There is a great need for a new approach, new methods and new tools in teaching, man's oldest and most reactionary craft. There is great need for a rapid increase in the productivity of learning. There is, above all, great need for methods that will make the teacher effective and multiply his or her efforts and competence. Teaching is, in fact, the only traditional craft in which we have not yet fashioned the tools that make an

ordinary person capable of superior performance. In this respect, teaching is far behind medicine, where the tools first became available a century or more ago."

Item

Sociologist James Coleman, author of the 1966 Coleman report:

"The trouble with school is that its focus is too narrow. -- schools are not designed to provide such adult necessities as the ability to manage one's own affairs -- or learning how to take responsibility for and work with others. Schools not only fail to develop these capacities, but by monopolizing young people's time, they also prevent them from acquiring skills elsewhere."

Item

In the case of Peter Doe, a family decided to sue the San Francisco schools for one million dollars because, although the student had a better than average IQ, he was a functional nonreader when he was graduated from high school. The suit contended that Peter Doe was graduated "unqualified for employment other than the most demeaning, unskilled, low-paid manual labor."

Item

The President's Commission on School Finance, Neil McElroy, Chairman:

"State Governments should establish systems to measure the effectiveness of educational programs including techniques for measuring progress and achievement in school as well as the ability to perform effectively in productive jobs or in college."

Item

Since the first accountability bill was passed in Pennsylvania in 1963, 27 states have passed some kind of legislation aimed at attempting to establish effectiveness of the educational enterprise. In fact, all 50 states and three territories have at least the beginnings of an assessment program, either through legislation or state department regulation. In addition to assessment laws, legislation has taken such forms as program budgeting, uniform accounting systems, management information systems, performance evaluation of staff, performance contracting, and voucher systems.

Item

First Minneapolis National Bank Annual Report, 1972, pg. 11, paragraph 3:

"The search for precise indicators of quality of life components proved difficult because existing data were often insufficient, inaccurate or accumulated too infrequently or on too broad a geographical basis. Most statistics reveal the quantity of effort expended rather than results or achievements attained. For example, much information is available about the amount of state aid for public education, but there is no comparable information about the educational results achieved."

Item

Minnesota Association of School Administrators, Educational Policy Commission. Erling O. Johnson, Chairman:

"The public has legitimate reasons for demanding greater accountability in the delivery of educational services. The emphasis must be more upon outputs than inputs, even though indices of quality have traditionally been associated with the latter. MASA believes that all school personnel must be specifically answerable for their performance. We have responsibility to each category of personnel to provide leadership in developing a comprehensive analysis better to define the mission, to establish and to devise more meaningful ways of assessing the quality of educational outputs. As demand for educational services increases and our resources become more scarce, it becomes evident that more effective means of resource allocation must be utilized. A strong need exists to develop procedures that will better support the decision making process and make possible a greater degree of accountability in education."

Item

The Minnesota Poll, Sunday, November 4, 1973, Minneapolis Tribune:

"Financial problems top state residents' concerns. Minnesotans are worried about money -- their own finances, the high cost of government, welfare waste, the squeeze on the elderly and taxes. Money is central to many concerns in a statewide survey of public opinion by the Minneapolis Tribune's Minnesota Poll."

In summary, current education seems to disappoint many, although it is quite costly. It is not clear how to improve the situation. Some authorities interpret the data to indicate that we do not know what to spend more money on or whether money makes a difference. At one time public education was acclaimed as our greatest national bargain. Something seems to have happened to that bargain.

BEST COPY AVAILABLE

Education in the past was as much a process of selecting students as it was a process of educating students. The process of that education seemed to be to expose students to areas of subject matter, select those students who performed well, and continue to expose those students. The goal of education was reached when some bright and qualified people passed through a curriculum of study and were qualified to perform certain specific duties such as membership in the learned professions. Education today, by contrast, has responsibilities that should be addressed to all the students in a community. This requires that the teaching be adapted not only to the brightest, most qualified and eager students but also to those who are less qualified.

The goal of reaching all students in a community means that it is more difficult to determine whether or not a school is doing its job. At one time the criterion for educational institution performance was turning out some bright, qualified students. If the high schools sent a number of students to good colleges every year, those schools were doing the job well. Today this criterion is inapplicable. The performance of the school should be gauged on what it does for all of its pupils.

This transition from education for a qualified elite to education for everybody took place in theory many years ago. In practice, this transition has not yet been achieved. Possibly the new goal requires a new delivery system. Group teaching was apparently successful at one time. Group teaching may have been satisfactory because the groups were homogeneous. The brightest and most eager pupils from a homogeneous community accepted the same cultural norms as the teacher did; the other pupils did not continue in school. The performance of students from disadvantaged homes and from minority groups has clearly indicated the extent to which group teaching depends on homogeneity in the classroom.

When the schools try to determine how much each student learns and in what length of time, they encounter two problems:

- A. the problem of adequate measurement, pupil by pupil, and
- B. the problem of the amount of responsibility for producing learning, pupil by pupil, that the educational institution faces.

Some defined responsibility seems to be in our immediate future. That responsibility has sometimes been termed accountability.

One argument against the idea that an accountability system can be put into operation today is that it is too soon. Another argument against introducing accountability says: accountability is evolving now; let it evolve at its own pace.

We say that the evolution of accountability is too slow and needs a boost. In our view accountability is slowly evolving both from the top and from the bottom in the school organization.

Program planning and budgeting systems are now working within some school districts from the top down. The managers and planners who work with this system find that after they go down two or three levels they have as many entities as they can take care of.

From the other direction, behavioral objectives or educational objectives are working from the micro-level upward. Some teachers today can write effective behavioral objectives for small portions of material to be learned. As larger blocks of learning are considered, the educational objectives are harder to write, harder to measure, and harder to program.

Thus we see an unmapped area between fiscal programs working from the top of the school organization down and instructional objectives programs working from individual learning blocks upward to larger blocks. It is our hypothesis that these things could be brought together in a management system, and that the merging of fiscal accountability with behavioral objectives could proceed much more rapidly. This gap closure can be effected through intensive development of management skills and related objectives.

Because the Coleman and Mosteller-Moynihan reports suggested that if we were to make money expenditure for education more meaningful we would have to do a major review of our goals and delivery system, and because many suggestions have indicated that a management system might be an answer to our problem, we turn now to an examination of management system design.

Frankly, it is our hope that we can apply logic and reason to problem solution. When Aristotle isolated the essence of man as his rational animality and held that a person's potentials were realized to the extent that those rational powers were actualized, he not only outlined what education was all about, he determined what our approach has to be to problem solving.

Since World War II many foundations interested in education, but particularly the Ford and Carnegie Foundations have distributed hundreds of millions of dollars in grants to carry on what might be called "piece by piece improvement of the educational process." The conclusion to be reached is that this approach has not been successful and that some kind of system of organizational improvement must be undertaken.

Rather extensive research as well as considerable experience in both business and education leads to the conclusion that there is a set of management principles that are common to all types of organizations. The set of principles could be called a management system. The experience referred to includes running or participating in many clinics and conferences for such organizations as the American Management Association, the National Association of School Executives, state and local school boards and school boards associations, state and local teacher and administrator professional organizations, local school districts, state and local Chambers of Commerce, and the Foundation for Minnesota Progress.

Management System Principles Include

1. A statement of the major mission of the organization.
2. Statements of goals and objectives essential to the accomplishment of the mission.
3. A careful definition of the product accompanied by an identification of the factors essential to the production of the product.
4. A description of the delivery system for production, outlining the mix of personnel, time, space, materials and budget required to produce the product. This is accompanied by inventory and appropriate appraisal and compensation systems. (Input)
5. An outline of the structural levels of the organization, describing the various responsibilities by function. (Organization chart -- Job descriptions)
6. An accounting of productivity, reporting both quantity and quality of the product produced on a unit and dollar basis. (Output -- preferably computer managed)
7. A data-based communications system, rooted in logic and reason (preferably computer managed), adequate to the task of:
 - a. assisting in problem solving and decision making, and
 - b. making possible adequate reports of productivity to appropriate interests.

The remainder of the report will be spent in explaining the application of the management system principles outlined above to education. Each chapter will follow the same structure.

1. A statement of the management principle with a short statement of educational application accompanying it.
2. A more extended exposition of the principle with examples and applications of the principle to education.

It should be said that the principles outlined here can be defended with considerable vigor. The examples and applications are simply that. They come out of the practice and experience of the writer as well as research that has been done in the past several years. It is perfectly possible that better applications exist or could be developed. Nevertheless, they are important inclusions as they give more meaning to the principles.

3. The inclusion of a series of working hypotheses with each chapter.

A working hypothesis can be defined as:

A proposition, or set of propositions, set forth to guide investigation in proving or disproving the validity of specified collections of partial data.

While the author is sure that information or experience already exist to validate the great majority of the hypotheses, an exploration of these hypotheses as a system, by field test, would permit us to see where the educational enterprise stands in management system development. With that information, we can contribute a great deal to the design of methods that would produce more effective educational service. Proof of the hypotheses would also make it possible to appraise the efficiency of a school system through appraisal of the results of its activity.

4. An outline of actions already taking place, contemplated, discussed or beginning to emerge in some state by one or more of the following agencies:
 - a. The Legislature
 - b. The State Department of Education
 - c. Local School Districts
 - d. The Courts

In the chapters, item 1 (statement of management principle) will be labeled Section A, items 2 and 3 (Exposition and Related Research Hypotheses) will be labeled Section B and item 4 (Action, Proposals, and Discussion from other States) will be labeled Section C.

A final chapter will outline the results expected from management system application.

Suggestion: Read Chapter IX, then
return to Chapter II and resume.

CHAPTER II

THE MAJOR MISSION OF EDUCATION

Section A

Management Principle One

For All Organizations is

A statement of the major mission of the organization.

For Education is

The major mission of the educational enterprise is the production of learning.

Section B

Schools in the United States just grew. Early schools taught reading so that the Bible could be understood and taught arithmetic so that anyone could operate a simple agricultural or commercial enterprise. Reading and arithmetic tended to continue to dominate frontier schools, both the Western frontier and the rural frontier until recent years.

Examination of the role of the school has been relatively recent. There is no common statement -- that is, a statement of major mission that is subscribed to by the majority of the citizens of this country. The major mission statement of the military during World War II -- Total Defeat -- Unconditional Surrender -- has no counterpart on the school scene. There is presently little unified understanding of the major purpose or purposes of public education.

A simple statement of overriding purpose would be extremely helpful for it would tend to reduce the controversies that have raged over related goals, type and structure of delivery systems, and expected results. Without such a statement, the most effective allocation of scarce resources is impossible.

Related Research Hypothesis

Hypothesis 1

It is now possible to state the major mission of the educational enterprise.

Section C

Action, Proposals, and Discussion
from Other States

1. Legislative

- a. The Legislature could make an official statement of the major mission to be accomplished by school districts that have been established by legislative action.

Our suggestion -- Production of Learning

CHAPTER III

GOALS AND OBJECTIVES

Section A

Management Principle Two

For All Organizations is

Statements of goals and objectives essential to the accomplishment of the mission.

For Education is

If the major mission of the educational enterprise is the production of learning, the question must be asked, "Learning related to what?" The answer, Learning related to goals.

Goals are broad categorical statements of intention with built-in measurability at an appropriate level of the operation but without time deadlines and without cost allocations at that point.

Goals for the educational enterprise could be:

1. Pertinent programs and services related to citizenship

Reading and arithmetic could be examples of such programs.

2. Pertinent programs and services relating to careers

Drafting for architecture and chemistry for municipal sanitation could be examples of such programs.

3. Pertinent programs and services related to personal development.

Music, art, and physical education could be examples of such programs.

Section B

Many states and local districts do not have statements of mission or stated goals. Where they can be found, most are stated in generalizations that cannot be programmed at any level.

There seems to be no observable relationship among the goals stated for various levels -- National, State, Local District, or the Classroom. Moreover, there seems to be little relationship between the goals stated at the various levels of operation and practice at that level. Where goals exist they seem to be isolated statements, unrelated to measurement or actual accomplishment.

Because most people in education genuinely want to help society improve, purple language tends to be used and great claims are made for the educational establishment. Thus, part of the problem becomes the practical matter of showing that education can accomplish its dreams.

To point out the practical difficulty that is faced, a goal from an eastern state is quoted:

"Schools must help every individual to develop a moral and ethical commitment to contribute to the physical and emotional well-being of all mankind, including himself."

along with a goal statement from a local district:

"To cause each student to achieve his or her full potential emotional, physical, and intellectual development."

Such statements lead one to speculate that tests for the practicality of goals could be devised. One such set of tests is as follows:

Test 1. Is it possible to program the goal in a local school?

Explanation Programming would involve management of the delivery system relating to time and space allocation, personal assignment, instructional materials development and budget commitment.

Test 2. Is it possible to measure the results of goals establishment and delivery system management?

Explanation Measurement would involve the determination of the amount of appropriate learning now possessed by the student or students that had not been possessed before.

Test 3. Is it possible to cost the result on an input and output basis?

Explanation Input costing would involve determining the cost of time, space, personnel, and materials.

Output costing would involve showing the number of units of learning produced over a specified period of time.

An example of such a realistic goal which comes from a western state is quoted as follows:

"To develop a state shared program for the construction of public schools."

A realistic goal from a local district states:

"To provide opportunities for citizens of all ages to pursue vocational goals throughout life."

If one were to design a plan to make goals setting effective, it would have to include at least the following:

1. To clarify and define goals and objectives from the state to the classroom level in a consistent objectives chain.

The phrase "objectives chain" relates to the unified relationship between and among goals and objectives at the various levels of operation. Thus, a progression from school board goal, to central office objective, to department objective, to classroom objective would constitute such a chain. In order to clarify this, it is necessary to identify criteria for goals and objectives to meet in order to be practical. This has been done.

Criteria for Organizational Goals and Objectives

- a. Have active behavioral verb
- b. Describe the action
- c. Identify the conditions of performance
- d. Establish the mastery criterion
- e. Establish the time span for mastery
- f. Establish "cost not to exceed" if possible

Applying these criteria to the problem of a school district, one finds that one must start with a school board goal such as:

"To provide opportunities for citizens of all ages to pursue vocational goals throughout life."

However, the school board goal meets only criterion a.

Central Office Objective

"To establish a course in Auto Mechanics by September 1974 at a cost not to exceed \$29,300."

The statement of this objective moves us to one specific, but only adds completion of Criterion f.

Vocational Department Objective

"Establish as one of the subdivisions in the Auto

Mechanics course a unit entitled 'Engine Tune-Up.' All 25 students are to be trained in the skills of this unit in a maximum of one week in the month of October."

The addition of the departmental objective now meets the requirements of Criterion e, but the chain is not yet complete.

**Vocational Teacher Objective
(one of many)**

"To assist the trainee until he can adjust the throttle to an idling speed of approximately 8 miles per hour in two minutes or less."

The addition of objectives at the classroom level meet Criteria b, c, d, and complete the goals and objectives chain.

2. To establish goals categories, each category amenable to actual programming at the district and classroom level.
3. To eliminate (or reserve for study) all goals statements that cannot meet the tests of programming, measurement, and costing.

Elimination of such goals will take some doing. For many years education has been surrounded by a semi-religious mystique which will not be easily given up, either by professionals or by patrons. However, if we are ever to begin the actual appraisal of educational effectiveness, it must be done.

With the limitations and qualifications listed above, we suggest the definitions and classifications that can make mission statement and goals and objectives establishment effective elements in a management system.

Objectives are specific statements of programs and services that may be selected to accomplish the goals that have the following characteristics:

- a. Programs are broken down into units of learning, each accompanied by an appropriate performance standard. Services are divided into activity units accompanied by performance standards.
- b. Time deadlines are established for each objective or group of objectives, related to the type of population or populations involved in the particular unit.
- c. Tentative cost allocations are established for each group or program of objectives and each type of service.

Related Research Hypotheses

Every carefully developed program, including a management program, is based upon certain assumptions, or evidences, or hypotheses. It is our belief that the hypotheses that are stated in relation to goals establishment in this chapter and in relation to other facets of a management system in other chapters are validated by evidence already in existence in most instances. However, because a hypothesis is a statement to be proved or disproved, it is felt wise to state the appropriate hypotheses for the survey of all who are interested in the application of management systems to education. A series of hypotheses and some discussion follows:

Hypothesis 1

It is now possible to develop educational goals for the state and nation that can be programmed and measured at an appropriate level of operation.

Hypothesis 2

It is now possible to classify every educational program under one of three goal categories:

Citizenship	(or civic adequacy)
Careers	(or occupational adequacy)
Cultural-leisure time	(or personal adequacy)

Hypothesis 3

It is now possible to develop school district goals in terms of the three above-mentioned categories, but in ways that give broad choice and discretion in the offering of careers and cultural-leisure time programs.

Hypothesis 4

It is now possible to develop local school objectives in terms of the three above-mentioned categories, but in ways that give broad choice and discretion to principals and teachers in the selection of subprograms in the areas of careers and cultural-leisure time programs.

Hypothesis 5

It is now possible to develop divisional or local classroom objectives in terms of the three above-mentioned categories, but in ways that give broad choice and discretion to teachers and pupils in the selection of subprograms in the areas of careers and cultural-leisure time programs.

The five hypotheses listed above represent one system or chain of objectives. They have to fit together. Rather than take sides in the controversy of whether or not the classroom objectives have to follow the state objectives or the state objectives have to flow from the classroom objectives, we see that the five levels of working from state to classroom have to proceed together. Thus, a state objective cannot be considered final until it is made to merge with the classroom objectives.

It is necessary to develop the chains of objectives concurrently. The sets of objectives mentioned in the above hypotheses are so interdependent that one cannot be developed without simultaneous development of the others. It is possible to work out development procedures for each of the levels. The procedures imply having criteria and having a program so that an objective can lead to an activity somewhere in the school system, and can also lead to a way of assessing whether or not the objective has been met.

It is also possible to develop a computer flowchart for programming consistency checks. The job of developing the goals and objectives under these levels would be so large that doing so without a lot of housekeeping assistance from a digital computer would be very difficult. A standard format for the objectives can be generated. The format would provide assistance in making the objectives uniform so that they could be read rapidly and easily; it could also provide a checklist. The format to be entered correctly would require that criteria and programs be available for the objectives.

The purpose is the production of learning determined in advance through goals established by school districts, states, and other representatives of the people. Responsible accounting can then be effective for pupils, parents, and other taxpayers through elected officers or other official representatives.

Section C

Action, Proposals, and Discussion from Other States

1. Legislative

- a. The Legislature could officially determine the goals categories within which the responsibilities of the public schools lie.

Our suggestion -- Citizenship
Careers

Cultural -- Leisure time activities

- b. The Legislature could instruct the State Department to identify those programs and services that should be classified under each category, but particularly citizenship, which the constitutional statement on education strongly implied was the first priority.

**Our suggestion -- Reading
Arithmetic
Political Systems
Economic Systems**

If such programs were identified, it follows that such programs should be mandated for all students in the state to a performance standard. This could be what the constitution meant by a "general and uniform system of public schools." It also follows that if these particular programs are mandated by the state, they will eventually be financed by the state.

2. The State Department

- a. The State Department could classify every program now being offered in the state under the goals categories established by the Legislature.
- b. The State Department could establish performance standards for each program and service being offered or performed in the state.
- c. The State Department could prepare and distribute a training manual to be used in training appropriate personnel in "Management by Objectives for Education." An appropriate number of trainers should be trained by the State Department so that an adequate number are available in each region of the state. There is no reason to assume that people can establish goals without training. Management by Objectives is the best training medium known to assist in the goal setting process.

3. The Local District could

- a. Establish goals for the District
- b. Test all goals for practicality

Our suggestion -- Can it be programmed?
Can results be measured?
Can programs be costed?

- c. Require each administrator to state periodically (annually or semi-annually) those objectives to be accomplished over that period of time with agreed upon evidences of performance.

Our suggestion -- Emphasis should be given to those objectives that make major contribution to facilitating the learning process. (Such as our objective to train principals in the uses of instructional objectives)

- d. Train all Board Members, administrators, and a percentage of teachers in Management by Objectives for education, i.e. train them in goal setting.
- e. Establish a continuous training program for administrators and teachers in the procedures for writing and field testing instructional objectives with accompanying performance standards. (Criterion Reference Tests) Because of the size of this job, it is suggested that one or two subject matter areas be selected for complete development and that samplings be made of the remainder of the subject matter areas.

4. Possible Judicial Action

- a. Legal action could be brought against the Legislature

For levying taxes for education without having made definitive statements of educational purpose.

- b. Legal action could be brought against the State Department

For the distribution of public money to local school districts (state aid) without requiring specification of educational purpose or evidence of performance.

- c. Legal action could be brought against local districts

For expenditures of public funds without providing periodically reasonable evidence of proficiency in accomplishing agreed upon goals. (Peter Doe case)

CHAPTER IV

MANAGING LEARNING

Section A

Management Principle Three

For All Organizations is

A careful definition of the product accompanied by an identification of the factors essential to the production of the product.

For Education is

The product is learning. Learning is defined as "Quantifiable changes in the behavior of the learner, attributable to the school."

The factors essential to the production of learning are identified as follows:

1. Diagnosis
 2. Prescription
 3. Skills development
 4. Facts and information
 5. Testing
 6. Problem solving and decision making
- a. application
 - b. valuing

Section B

Many people insist that education does not have a product, that it is a process only that is conducted between and among teachers and learners. Other people suggest that the product is the mature citizen of proven worth, who is operating effectively many years after his schooling has been completed. We do not believe this to be so; but if it were, it would be impossible to hold the educational establishment responsible for what it accomplished. A process is very difficult to measure and the mature citizen has had so many other influences affecting his life that it would be impossible to say that schools were responsible for either his success or failure. X

It is possible to define the product produced by the schools. That product is LEARNING. It can be measured reasonably well, and it can be measured during the years of school and shortly thereafter.

For this, the schools can be held responsible. If, indeed, learning is the major responsibility of the schools, it needs to be carefully defined; and those functions that are essential to its production must be identified. This is not so easy to do as might appear on the surface. Requests put to Board Members, administrators and teachers in hundreds of clinics failed to produce such definition and identification. When a few were found that might stand inspection, there was no agreement among the parties.

It is obvious that it is difficult to hold education responsible for producing what has not yet been defined with common agreement, or for examining productive effectiveness when the factors of production have not been discussed.

Yet the definition of product and the identification of the factors of production seem to be common elements in the management system of any kind of organization. We believe that it is possible to apply management system principles to education as suggested above.

While we do not defend this definition of learning as the final word on the matter, it does specify three things:

1. The results must be measureable --

Statements often made that education produces many magnificent results that cannot be measured, do not stand careful examination.

2. Something has to happen to the learner --

No matter how dedicated professionals are, unless something happens to the learner, learning has not taken place.

3. The school can be held responsible only for what it does --

It cannot be blamed or praised for learning that has taken place at the drugstore, in the home, or on television.

Nevertheless, in order to make such a definition useable, it is necessary to define the programs and services that are developed to meet the challenge of goals established.

To implement a planned solution, it would be necessary:

1. To clearly identify by definition, classification, and other means, the programs that are to result from goals development and delivery system management.
2. To explore methods of determining the amount of learning produced by such programs (including criterion reference tests) in such areas as:
 - a) Facts and Information (History-Chemistry)
 - b) Skills Development (Reading-Typing)

- c) Problem solving and Decision making (How do you improve a municipal water supply?)
- d) Attitudes (I don't like school)

Moreover, it is undoubtedly essential to examine the role of individualized instruction in the productive process.

True individualized instruction has been a long-held dream. The reality of individual differences in students is one of the few extensively provable research facts in education. There have been a few attempts toward individualization, and variable progress plans are a step in this direction; but up to now we have been unable to develop a complete system that makes a major impact on this problem.

We have been too harassed by great cultural lag, unclear purposes, multigroup burdens, population changes and money problems. Frequently we have not been able to do what we knew how to do.

Nevertheless, the events and developments of the past few years have made it seem more and more possible to accomplish the goal of true individualized instruction. We have discovered variability in school spaces, in time allotments, in programming, in testing and grading; we have arrived at clearer statements of our educational goals; we have begun to work with instructional objectives -- objectives that state, specifically, what the learner will seek to achieve, be it skill, knowledge, application, synthesis, feeling, attitude or judgment. We have started to explore a financial accountability that relates space and staff costs to specific learning activities.

All this requires a closer examination of the teaching/learning process. Let us review those functions to see what such analysis will yield.

(Exhibit #1). See Addendum #1

For more than two thousand years, the teaching/learning function has consisted primarily of the first two activities shown on this chart -- skills development, and facts and information. All of us are familiar with everyday examples of skills development in the schools. Reading is a skill, and so is arithmetic. Typing is a skill, and so is blocking in football. This function of the teaching/learning process is relatively well understood, whether it be a skill required by society, like reading, or one that is not -- like typing. Much of our time in the public schools is spent on this function; the more traditional the system the greater the time so spent becomes. No one argues that skills development is not an essential part of the teaching/learning process.

The area of facts and information has had just as long a history. In fact, tribal anthropology gives examples of both areas. The skills involved might be hunting skills, and the facts and information might be the local geography of forests and caves; but there is no doubt

about the long existence of both facets and their crucial relationship to the maintenance of the tribal type of society then.

Nevertheless, the area of facts and information has been an increasing problem in our modern society. The volume of information is now doubling every ten years. It has been said that St. Thomas Aquinas, the 13th century theologian, was the last man to know everything. This tremendous increase has made necessary the development of classification systems so information can be found, libraries and other depositories where it can be sorted and stored, continuous research so that it can be checked, and departments and courses so it can be organized for learning.

But the most important problem that this increasing volume of information raises is the problem of selection. What facts and information should the schools use when not a hundred thousandth of what might sometimes be useful, can be included? This problem we have not solved. And it may be it can never be solved through the use of textbooks, encyclopedias, and professors' notes. Some new method of availability will have to be found.

The process of testing, the third step on the chart, is only more recently with us. We have had the Socratic use of questions by teachers, and the occasional practice of reading for the township trustee at the end of the year, but most evaluative techniques based on various types of testing have been with us only since World War I, a very short time span compared to the longevity of the educational process. As valuable as the development of testing has been, it does not, particularly in the area of facts and information, deal crucially with the critical measure of his learning -- his behavior. How does the learner behave after he has learned? We do not usually check the effectiveness of the institution in this way. It is probable, however, that such evaluation is in its future.

These three processes - skills development, selection and acquisition of facts and information, and testing, make up the total educational pattern in most school systems in the United States. Recognizing this limitation is not a criticism. American education has done a tremendous job with the available resources and the state of the learning arts. But we must recognize that other methods and other resources have been developed -- or at least methods and resources have been utilized in different ways in a new pattern of responsible learning activity. Westinghouse PLAN materials and the various other collections of instructional objectives are such recent developments.

Even as we take a fresh look at the three central areas, we are now also forced to realize that there are additional essential functions in the teaching/learning process that are just as necessary, perhaps more necessary, even though they have seldom been a planned part of the approach to the education of students.

(Exhibit #2) See Addendum #2

Gifted and perceptive teachers have always performed other functions related to learning, and two of them you see here. They are:

diagnosis and learning prescription. Diagnosis is sometimes called pre-assessment. It is obvious that diagnosis cannot be done by the group -- it must be done by the individual -- and thus it is a time-consuming and multiskilled operation. True individualized instruction leads inevitably in this direction since it must deal with the current learning problem of each individual.

There is a simple, recent example of diagnosis. When a district decided to do a twelve-week Saturday program for selected four-year-olds, it needed to know, before starting the program, what and how much the students already knew. One of the things it needed to know was how many of the primary and supplementary colors these four-year-olds knew. This is a part of the regular kindergarten teaching/learning program. Test results revealed that all but one of the children already knew all of the colors. This diagnosis produced data that forced a review of the teaching of colors in the kindergarten, a progression job which should have been done anyway.

Learning prescription is a logical follow-up of diagnosis. It says, "What do we do about learning progression?" Now, we must return to the center of the chart and ask the following questions: What development skill or skills are necessary next? What facts and information are essential next? And what level of quality in the two is required?

As important as learning prescription is, it is primarily a mechanical problem. Catalogues, lists of learning units, aids of all sorts, appropriate teaching skills development, and sources of required information determine the learning prescription and thus what the student does next. Learning prescription is impossible without diagnosis.

We have briefly discussed the two pre-teaching functions of diagnosis and learning prescription. Now let us deal with the two additional teaching functions, that are seldom delineated but are just as important: problem solving and decision making.

(Exhibit #3) See Addendum #3

Both can be considered a necessary followup of the functions that have gone before. They relate to the orderly examination of the actions or behavior of the learner after he has gone through the learning process thus far.

There are two types of problem solving and decision making. One type depends upon the availability of objective data and the skill to manipulate that data in problem solving and decision making. This we call Application. Balancing a check book could be an example of application, but so could the moon shot. The examples simply vary in difficulty. The other type of problem solving and decision making occurs when elements of the data involved are subjective in nature or are non-existent. Such situations are in the paper every day -- Watergate, abortion, taxation, minorities and a myriad of others. This we call Valuing.

Skills alone are interesting and so are facts, but they have no real social significance unless they can be marshaled and used to solve practical problems. Both are the use of logic and reason in the situation and relate to all of the higher cognitive skills to which Bloom refers. These are, ultimately, the measure of the educated citizen.

Let me give you an example. Some years ago a class decided to take, as a project, finding out why the water supply in the community was so bad and what might be done about it. Practical examination of the problem and its solution required most of the skills with which the school dealt -- skills of writing, of arithmetic and finance, of civics and municipal government, of petition and referendum. The class's work had a practical effect upon the expenditure of considerable money to improve the water supply in that community. Problem solving through application and valuing were a measure of the learning.

This then is a functional analysis of the teaching/learning process. Interestingly enough, the process is exactly the same whether it applies to learning or to teaching. If this is an appropriate analysis of teaching/learning, and it has been field tested enough to have some validity, why have we arrived with so little, so late at more individualized instruction?

There are several reasons. First, the state of teacher training had not improved enough until after World War II to make such instruction possible. Before that, teacher training depended mainly upon memory skills and rote learning. Second, until some years ago, we didn't have the hardware capacity to handle the number of instructional units that would be required for individualization. Third, until recently, the software in instructional units was developing so slowly that the hardware had small potential for any educational areas except mathematics and business.

Major hopeful signs are developing. The hardware capacity is now with us; and there is an increasing development and production of educational software. Several regions in the country are working on the instructional units. The implementation of plans for the development of curriculum banks of instructional objectives will signify a new day for teacher and learner.

What are some of the applications of the educational model here outlined. There are far more than will be given here. Application one relates to relevance. Young people are demanding that curricula be relevant and that they participate in the relevance. Their demands deserve consideration. An interesting thing was discovered in a high school contemporary discussion course recently. The students chose to discuss such subjects as "Black Power," and they wanted to start at the valuing end. Although they didn't say it exactly this way, their evaluations at the end of the course said in effect -- "I guess learning just doesn't proceed that way. Maybe we should have known some facts about the problems before we started to discuss them." And they are right. That learning, like any other, should have started with diagnosis and proceeded through the processes to problem solving. Following the steps of functional learning is the road to relevance.

Application two relates to team teaching. It is obvious from the model that if a team of teachers, representing all these learning functions, taught a group of students, the team -- and the learning situation -- should be highly effective.

This then is the growing model -- too short and not enough meat on the bones yet, but it, as an outline, is understandable. The trend of the future is never completely clear, but one can speculate with some reason that in a few years one might find the following developments:

1. There should have been completed, refined educational objectives at the board, division, department, and classroom levels. This is the first step and essential to all other planning.
2. There should be a markedly different curriculum based on a true cafeteria of learning -- behaviorally measured instruction units.
3. There should be a much more professionalized staff -- through re-definition, through identification of various responsibility levels, through re-training, through assignment in multi-dimensional skills areas -- working at appropriately higher rates of compensation.
4. There should be a measurably different physical plant, related to and supportive of an increasing amount of individualized instruction.
5. There should be a greatly increased ability to measure changes in behavior. Changes in behavior constitute learning.
6. Assuming the previously mentioned developments, there should be increasing ability to apply the planning, programming, budgeting, evaluation system to our school operation, a system that relates itself increasingly to industrial, commercial, governmental, and public service functions.

A final word about the state of American education. A reference was made earlier to tribal anthropology. The history of tribes suggests that in times of stability, the educational system emphasizes skills development and facts and information, with only a minimum of informal evaluation thrown in. Despite two world wars and other lesser disturbances, the time since the American and French Revolutions has been a time of relative stability. Educational emphases over this period have supported this probability.

But when times of great stress develop, when the social structure is threatened -- and survival is threatened, all societies tend to add -- either formally or informally -- the functions of diagnosis, learning prescription, problem solving and decision making.

We may now find ourselves in such a time of stress. Since the hydrogen bomb and Sputnik, far more people doubt our eventual survival. The unrest in the undeveloped countries, the resurgence of minority groups, the increase of crime in the streets, the slow deterioration of religion, the disintegration of belief in one's fellowman, the increasing dissatisfaction of youth -- all these reduce our sense of security about the future.

We may have an essential stake in the survival of our society through what we do in the re-vitalization of our learning function. An approximate quotation from tribal anthropology has survived to remind us. It states:

Education is the center of societies' adjustments to the Universe -- and thus the key to its survival.

Related Research Hypotheses

Hypothesis 1

It is now possible, when the major mission of the schools is identified as the production of learning, to define learning so that it becomes practical and useful in school operation.

Hypothesis 2

It is now possible to identify the factors essential to the production of learning so that this knowledge becomes useful in the arrangement of the delivery system and in the allocation of resources.

Hypothesis 3

It is now possible, through goals development and delivery system structure, to define the programs and services that are the responsibility of the educational enterprise as well as the quantity and quality of the learning produced thereby.

Sub-hypothesis 3a

Through the use of pre-test, post-test it is possible to measure the learning produced in the area of Facts and Information (history and chemistry).

Sub-hypothesis 3b

Through the use of pre-test, post-test it is possible to measure the learning produced in the area of Skills Development (reading and typing).

Sub-hypothesis 3c

Through the use of pre-test, post-test it is possible to measure the learning produced in the area of Problem solving. (How do you improve a municipal water supply?)

Sub-hypothesis 3d

Through the use of pre-test, post-test it is possible to measure the learning produced in the area of Attitudes. (I don't like school.)

Section C

Action, Proposals, and Discussion from Other States

1. Legislative

- a. The Legislature should instruct the State Department of Education in conjunction with local school districts to arrive at a commonly acceptable definition of learning as the major mission of the schools along with an identification of the factors essential to the production of such learning.

Our Suggestion -- Quantifiable changes in the behavior of the learner, attributable to the school.

Our Suggestion -- Diagnosis

Learning prescription

Skills development

Facts and information

Testing

Problem solving and Decision Making
through

- a) application
- b) valuing

2. The State Department

- a. Comply with item a under Legislative Action

3. The Local District could

- a. Identify locally, a definition of learning for use in the district, along with an identification of the functions essential to its production. Review personnel assignments to see whether or not the definition and identification could result in changes in assignment or specialization.

Our Suggestion -- If the factors essential to the production of learning are really diagnosis, prescription, etc., would it be possible to specialize staff along those lines?

4. Possible Judicial Action

a. Bring legal action against local districts

For failure to define what results are to be expected from the educational process and failure to provide any measures thereof.

**EXHIBIT
1**

THE BASIC TEACHING/LEARNING FUNCTIONS

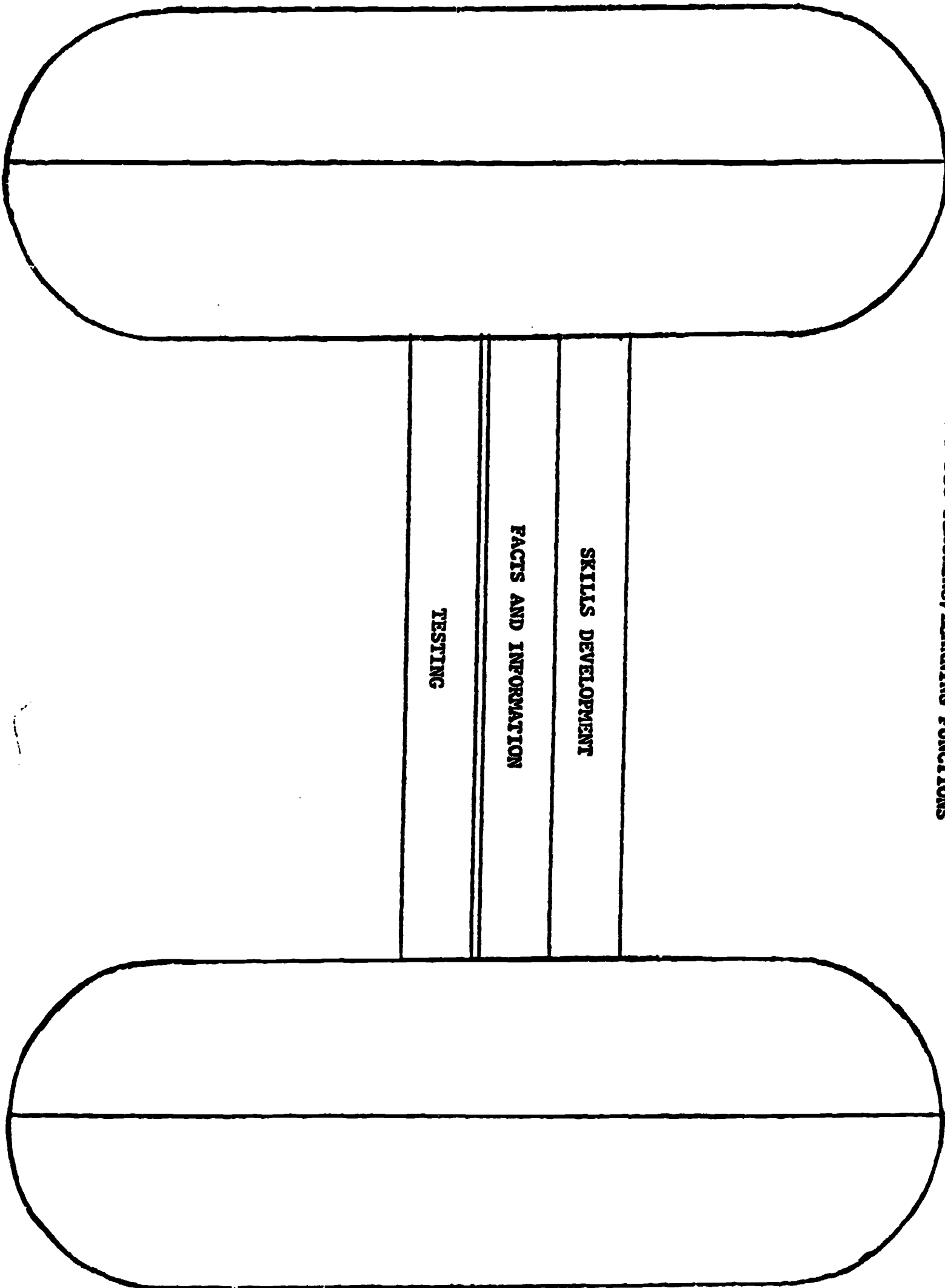
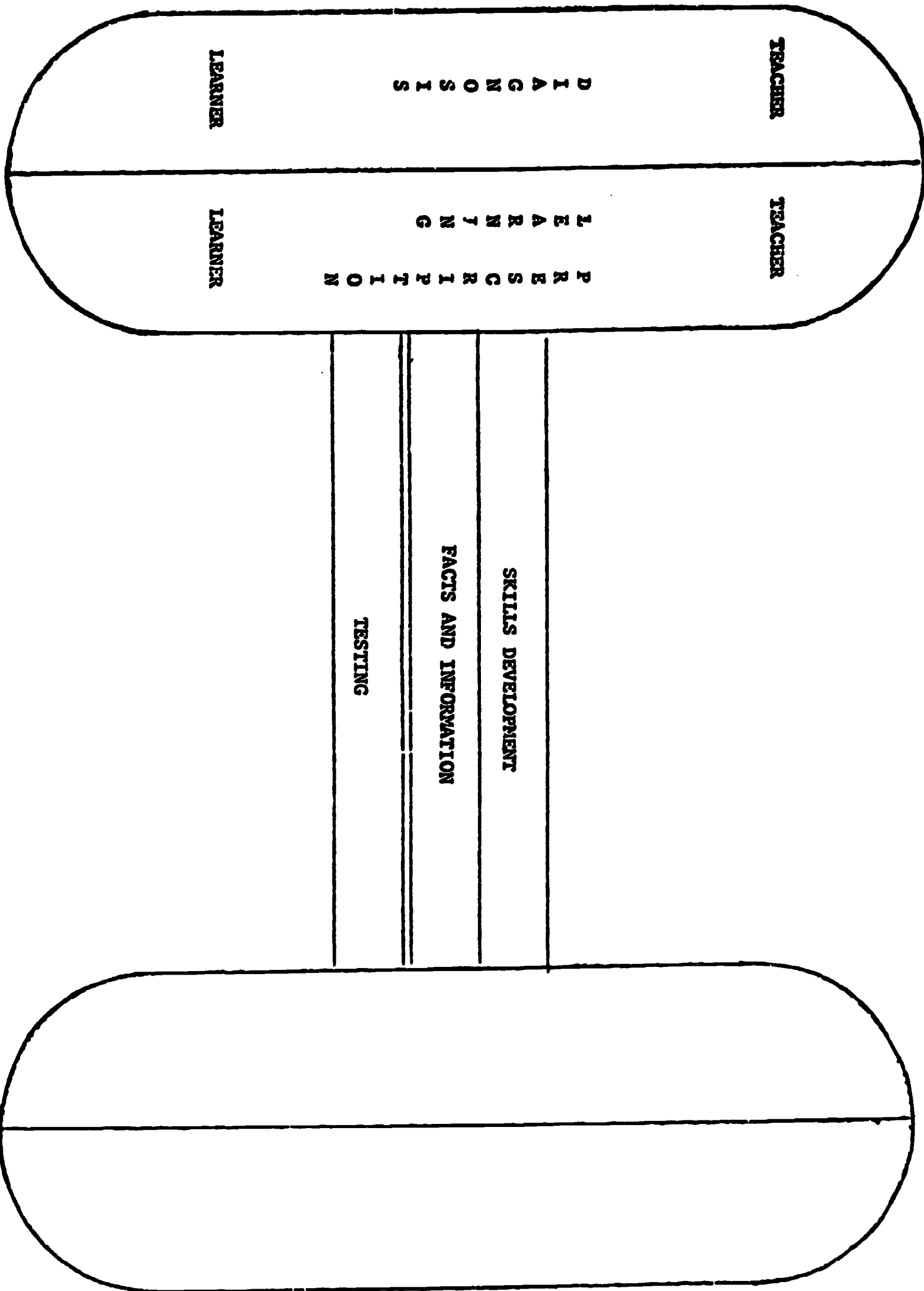
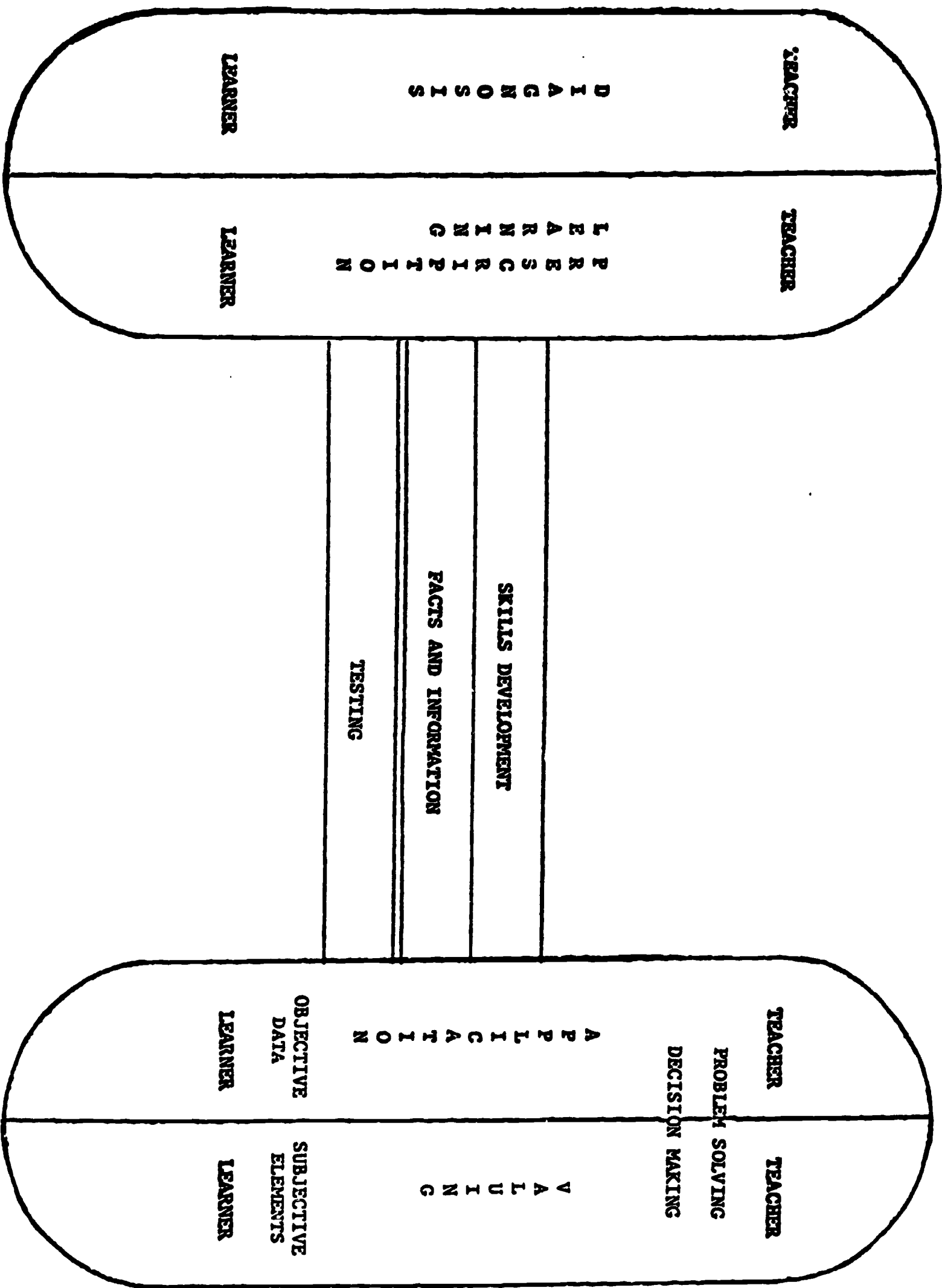

EXHIBIT
2

THE BASIC TEACHING/LEARNING FUNCTIONS



THE BASIC TEACHING/LEARNING FUNCTIONS



**The Teaching/Learning Functions
An Educational Model**

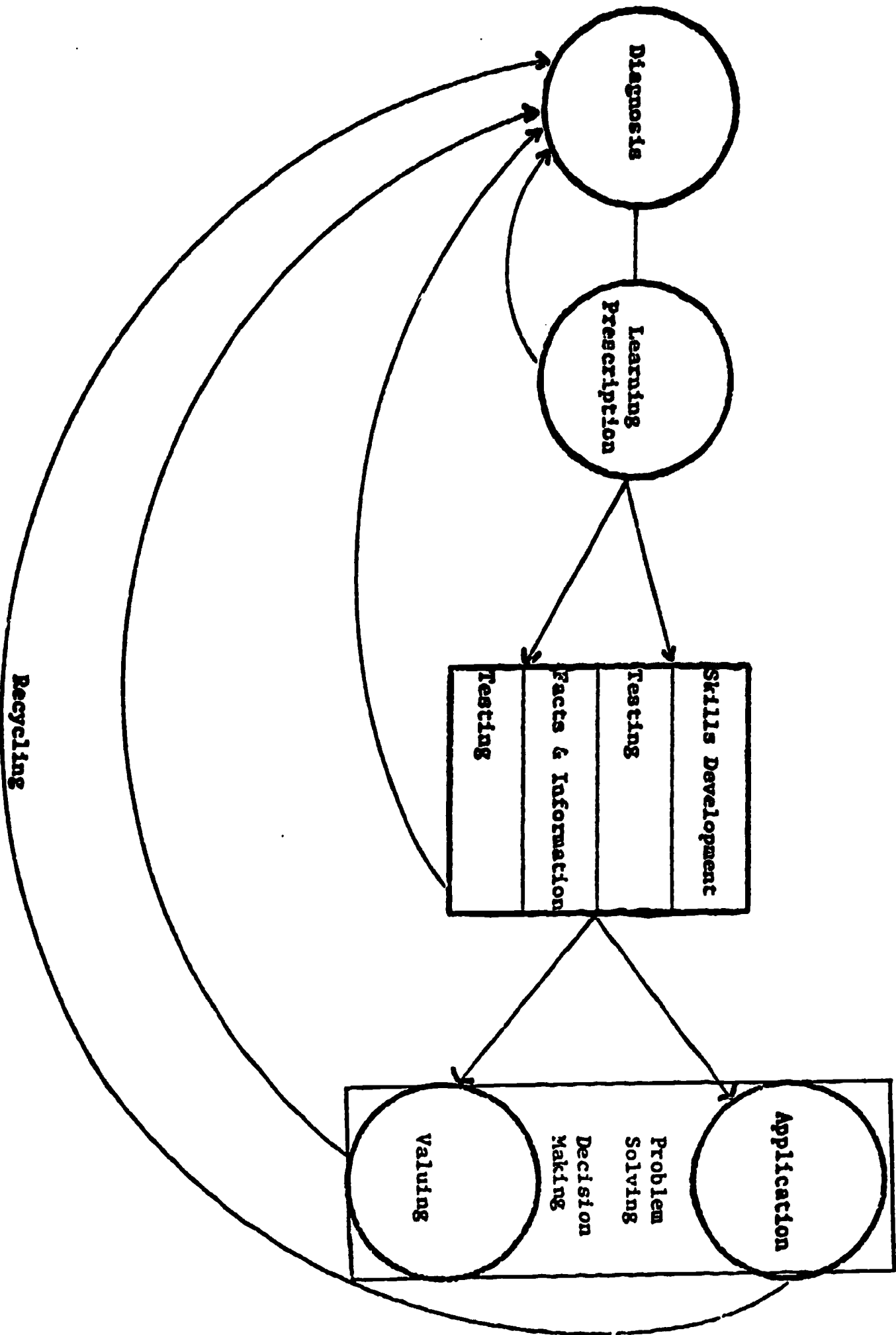

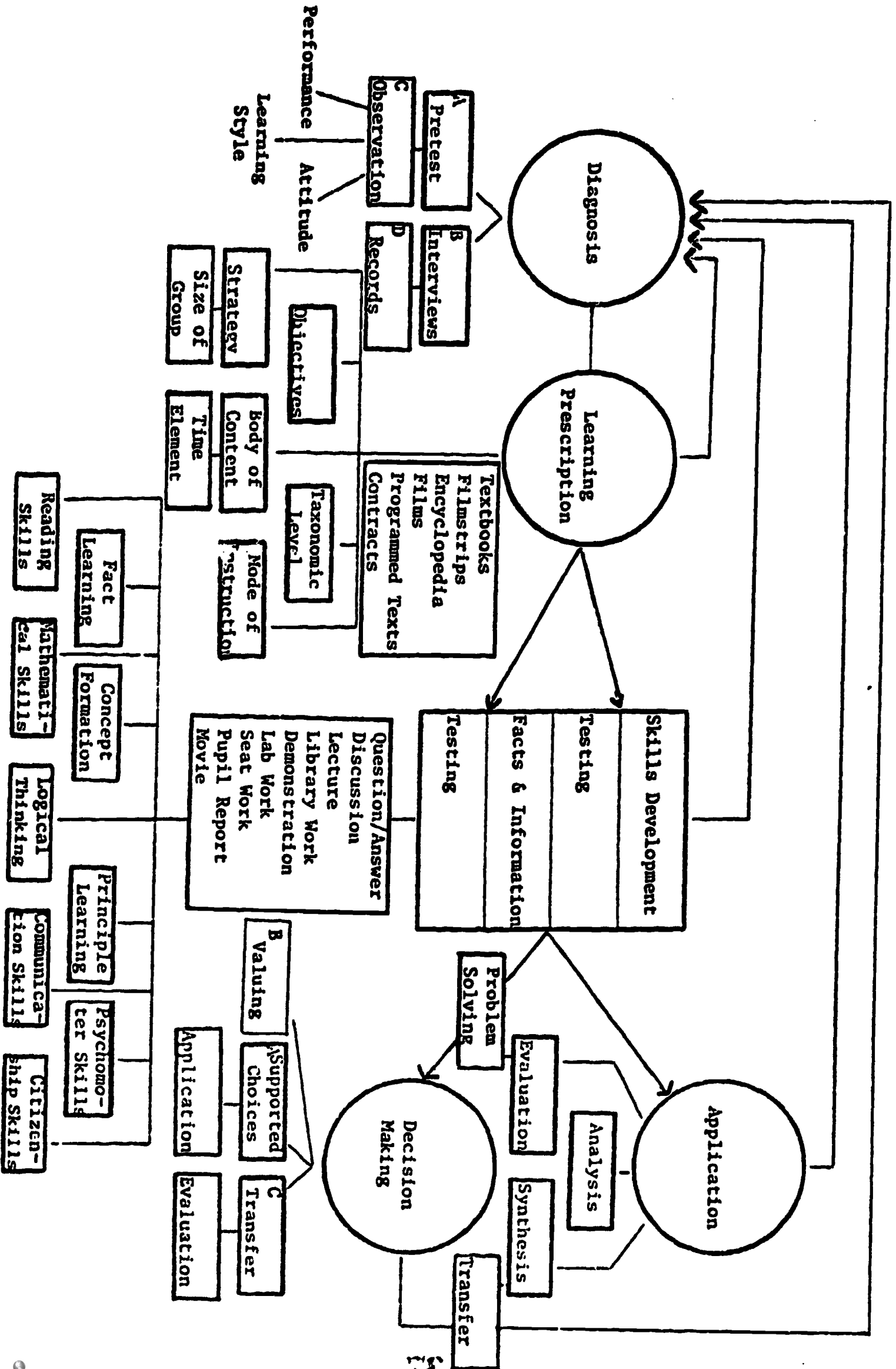

CHAPTER V

THE DELIVERY SYSTEM

Section A

Management Principle Four

For All Organizations is

A description of the delivery system for production, outlining the mix of personnel, time, space, materials and budget required to produce the product. This is accompanied by inventory and appropriate appraisal and compensation systems. (Input)

For Education is.

The delivery system depends upon the statement of mission, goals and objectives. If the production of learning (output) is paramount, along with delivery system processes that include individualization of instruction, then relationships of personnel, time, space, and materials and organizational structure to each other will be conditioned by learning production to the maximum and the process of individualization as a by product.

Compensation is the method of rewarding personnel for both process and product.

Inventory is the method of maintaining continuous and effective supplies.

Budget is the means of bringing the other factors into being.

Appraisal is the process used for determining the effectiveness of the delivery system.

Section B

Although Delivery System is a relatively new term related to the educational process, it has significant uses for creating understanding of what the problem of educational production is and how that production can be improved. The delivery system can be defined as the production function, standing between goal and result.

Goal -----> The Delivery System -----> The Result

Analyzing the delivery system for efficiency and effectiveness has its difficulties. However, the difficulties do not arise from the delivery system itself. They arise from problems that begin with goals and results. If goals are not stated clearly enough so that expected results can be well understood, the possibilities for setting up a maximum delivery system are remote. This, it is suspected, is the case with education. Almost no meeting of educators occurs without major discussion of what education is supposed to do. The same problems face the lay citizens served by education. The surprising aspect of the matter is that education has been received as well as it has, possibly because of the semi-custodial or baby-sitting function that has always accompanied it and because of its low cost in the past. The past is the past, and costs are no longer low, and fewer and fewer people accept the educational enterprise without question.

Understanding the delivery system depends upon two things:

1. understanding the functions essential to the production of learning, outlined in Chapter III, and
2. understanding the factors of production which are as old as Adam Smith and as young as today.

The production factors are:

- a. land
- b. labor
- c. capital, and
- d. entrepreneurship (leadership)

We identify them somewhat differently than the traditional economist does, but all of the factors could be classified with traditional titles if it were more useful. We do not do so because of the common use of many educational terms and the belief for many years that education was a non-economic enterprise. We believe that it is an economic enterprise. If it has not been in the past, it certainly is now because of the amount of society's resources it uses. When its productivity can be better explained, its economic nature will be better understood. These factors are:

- a. Materials -- instructional and other -- inventory
- b. Personnel -- teaching and administrative
- c. Time -- by the year, by the month, by the week, by the day and by the hour
- d. Space -- to contain the entire enterprise
- e. Budget -- costs of all functions
- f. Organizational Structure -- interrelationships of the functions
- g. Communications -- solving problems
making decisions
reporting progress and results
- h. Appraisal -- determining the effectiveness of the educational enterprise, particularly the delivery system

Instructional Materials

Without attempting to downgrade other materials often essential to the running of schools, we will, because of space limitations, confine our discussion to instructional materials. Instructional materials have always been with us since the use of the ancient stone tablets. In recent times they can be said to include textbooks, curriculum guides and fugitive materials. In some schools audio-visual materials are included.

The use of the materials above described suffer from certain disadvantages:

- (1) They tend to reflect the position of the author only.
- (2) They tend to confine the curriculum to a particular set of materials.
- (3) They make it difficult to determine student competence.
- (4) They make it impossible to establish a single competency standard.

Materials as used at present tend to create diversity as great as each individual teacher may determine for himself or herself. While there are certain advantages, there are also disadvantages. It is difficult to talk about the educational system in a local district, let alone in a state, if the goals and estimation of results differ in every classroom. The tendency has been in the past to hire a teacher and say, "You are certified in subject A; here is a classroom; here are textbooks -- please teach."

Fortunately, developments in the past few years have made it possible to retain a large amount of diversity -- diversity required for individualized instruction -- and at the same time to develop some commonality in curriculum, some commonality in measures of competence and a tremendous increase in the amount of instructional material available. Diversity should reside in the choices available to teacher and student, not in the quality of the instructional materials used.

This development has been the creation of the instructional objective, accompanied by the even more recent criterion reference test. Dozens of partial collections have been developed in the past few years in most subject matter fields. Unfortunately, they have been developed in individual situations and thus are incomplete, are created to different formats, are impossible to classify for library purposes, and are generally available only on a very limited basis.

This should be expected in what started out to be an experimental attempt to develop instructional materials of more scope, more definitiveness, and greater measurability. Because of the current differentials described above, the usefulness of the instructional objective presently tends to be confined to the individual school district, the individual subject matter area, or the individual classroom.

It is quite possible to remedy this defect -- and perhaps it is time. Comprehensive collections of instructional objectives could be developed in each subject matter area by:

- (1) Commercial agencies like textbook companies for broad distribution,
- (2) Professional organizations such as the National Education Association, the American Federation of Teachers, the National School Boards Association or the American Association of School Administrators,
- (3) Regional accrediting associations such as the North Central Association,
- (4) Consortia of local school districts,
- (5) State governments, or
- (6) The Federal government

If any one of these agencies did the complete job, more instructional materials would be available to teachers and more choices available to teachers and students than have ever been possible in the history of education.

No less important would be the development of competency standards for each instructional objective in the curriculum. It is now possible to do this, and it needs to be done. The criterion reference test holds great advantages over the national norm test for this purpose. A national norm test is a sampling of what the average districts in a broad region teach in each subject matter area. The national norm test performs very well for the purpose for which it was conceived, i.e., the placing of a group of students or others in a prescribed proficiency range. Such a test does very well when one desires to select or reject candidates for college entrance or draftees for military service. Such tests do measure the general competency of a given student population but remain quite unrelated to the efficiency or effectiveness of the delivery system of a school district. They tend to indicate the kind of student population that a school district has -- not what a school district may have done or have failed to do.

On the other hand, the criterion reference test, because it is connected to an individual unit of learning, has some specific advantages:

1. It shows whether or not the student knows a particular unit of learning to a competence level before instruction.
2. It shows, if the student did not know the unit and the school then taught it, whether or not the student has learned the unit to a minimum competency level.

The use of the criterion reference test makes it possible to develop competency standards for students, particularly in subject

matter areas that might be considered crucial for participatory citizenship, such as reading or arithmetic. The use of such tests also makes it possible to get some idea of how well the delivery system is working. This can be done fairly, provided that several years of history of the use of such tests, indicate, through careful records keeping, what should be expected of the type of student population resident in the district.

On a more sophisticated level, it is possible to determine both quantity and quality through the use of instructional objectives. Because the minimum level of competency expected for student success is seldom the maximum learning that can occur in a learning unit, it is possible, once a minimum competency level has been firmly established, to determine quality levels above the minimum. Many students would undoubtedly accomplish one or more quality levels above such a minimum.

(An example of an instructional objective with performance standard may be found at the end of Chapter IV, labeled Addenda 1 - 3)

Personnel

The education business is a people business, both with regard to staffing and to clientele. It is probably the most labor intensive agency that deals in services to the public. Because of this, the way in which personnel resources are marshaled to the task is of extreme importance. While such matters as certification, tenure, and collective bargaining are of considerable importance to personnel in education, we will not deal with them in this treatment. We will deal with just two aspects of the personnel problem, i.e.:

- (1) training and re-training,
- (2) specialization

Assuming that the educational enterprise engages in the use of collections of instructional objectives, there are matters of importance to teachers. There needs to be training in the writing, field testing, and refinement of instructional objectives. This can be done in pre-service training or in in-service training, depending upon where the teacher is in professional development. For teachers' in-service, we believe that intensive in-house training is the most productive. For all teachers and many administrators, the minimum productive period seems to be two to three days of clinic. Such clinic experience needs to be repeated every two or three years. When the collections have been completed, except for periodic refinement and review sessions with the collections, training in use of objectives is sufficient.

To be most effective, a training manual should be developed to be used in training teachers with something of a uniform approach. Such a manual has not yet been completely developed, but it is a perfectly possible and necessary development. If administrators are to be effective in assisting in the production of learning process, they need the same training.

Just as important a development is the consideration of personnel specialization. Specialization, known as division of labor to economists, was well known in the 1770's and is thus hardly a new idea. However, it has not been applied to any degree to education. The use of teacher aids, para-professionals and volunteer parents has recently emerged but that addition does not seem to have changed procedures very much. The Conant study in Portland, Oregon, entitled "Teacher and Para-professional Work Productivity" found that in traditional elementary classes, only 1-1/2 hours of five hours of teacher presence could be classified as educational work as defined in the study. The range was a variance of from 48 minutes to two hours. When a para-professional was added to a class, only an average of 11 minutes per day was added in educational work. While there was no measure of actual productivity in learning, the increase in the time spent in educational work was inconsequential. The conclusion was that much greater change in personnel utilization and other aspects of the delivery system was necessary if educational productivity was to be improved.

There would seem to be some hopeful developments in the line of greater specialization. Chapter III outlined the functions essential to the production of learning. Thus, if the outline of these functions is valid, it would be perfectly feasible to train teachers and administrators in one or more of the functions there outlined. Eventually, a staff could be made up of specialists in the functions of diagnosis, prescription, facts and information, skills development, testing, problem solving and decision making with emphasis on application and valuing. Such specialization should surely result in greater productivity. It undoubtedly would result in the reduction of time spent in non-professional duties, tasks that professional teachers have always objected to more or less. More will be said about this in the appraisal section.

Time and Space

The use of time has not changed a great deal in American education in a great many years. Traditionally, school runs for nine to ten months, with a usual vacation around Christmas and Easter and a summer vacation pre-empting at least July and August. Almost always the sessions are held Monday through Friday, and the sessions average about six hours daily. In the elementary school, the usual practice is half day blocks, in secondary schools it is the fifty minute period. While various types of grouping have been tried and abandoned every decade or so for the last fifty years, there has been little real change in the time structure. The facts are that our practice still deals more with instruction in miscellaneous groups than it does with individual need.

Other options are possible. Publications have already outlined the fact that there are more than fifty ways of arranging the time by year, by month, by day and by hour, presently operating somewhere in the world. There is some evidence of change although most of it has been a change in the pattern of the six hour day with little change in the other time segments mentioned. Exceptions are the four quarter, three semester, or 45-15 plans. However, they relate primarily to different arrangements of school scheduling to make greater use of school buildings, rather than instruction related time allocation.

Other options are beginning to appear. The non-graded primary and other types of variable progress plans have appeared in the elementary school, and mini-courses and modular scheduling are attempts at the secondary level to modify time strictures in favor of more flexible instruction. More encouraging are the developments of Individually Prescribed Instruction, originating at the University of Pittsburgh, Individually Guided Education from the University of Wisconsin, and Westinghouse Learning, a commercial approach to individualization. All use some form of instructional objective curriculum along with other changes in the delivery system. A matter of importance is that some of these programs have demonstrated superior ability to deal with the problems of some minorities and the socially and economically disadvantaged. More is learned when these programs are used. There is also evidence that a greater amount of learning is produced with other types of student population -- the average and the gifted.

As welcome as these developments are, they are not enough. The diversity of our student populations compared to fifty years ago demands that schools move quickly to individual programming for each individual student. This means that some of the learning will take place on an individual basis, some will take place with small groups where the individual needs are the same, and occasionally, large groups may be assembled when information is pertinent to the needs and capacities of such groups.

This means that we need to know what the student knows now and, from that point of departure, what he needs to know next. This obviously requires the diagnostic and prescriptive services outlined in Chapter III and the kind of definitive curriculum that was described earlier in this chapter.

The growing insistence on the part of teachers and students that learning choices be made available, makes even more essential the services of diagnosis and prescription and a tremendously broad diversity of curricular materials.

The type of space furnished by the school should obviously reflect the kinds of programs and services that are enclosed. If the school building is an umbrella over programs it is probable that the double loaded corridor classroom building, by far the most common type of school building found in most districts, does reflect accurately the program that most schools have had.

There have been some pioneering changes, some suggested by architects, many developed by various types of school committee. The American Institute of Architects, the American Association of School Administrators and the School Facilities Council of the Ford Foundation have all had roles of leadership in the development of schools designed to house programs which are presently changing and programs as yet undesignated.

There are problems that relate to school space. One is that no-one can predict exactly what school programs and services will be fifty years from now. Because this is so, it is probable that new school

buildings should have far greater flexibility than ones built in the past. The probability of individualized instruction means that the ability of changing the type of space enclosed in a building should be maximized. It is possible that new school buildings should be built with a much shorter economic life than tradition has established in the past.

A greater problem is the problem of school buildings with many years of remaining economic life that reflect the programs of the past but are less than perfect housing for developing programs and programs for the future.

While all new buildings might be ideal, no school district should fail to develop new programs because its buildings do not provide a perfect fit. All buildings can be modified to provide greater flexibility and many methods have been devised for such modification. Here the reader is referred to the publications of the organizations mentioned above.

While we make no attempt in this short document to detail the kind or kinds of flexible buildings that should develop, we should indicate that the building of the future should most certainly contain one or more learning centers. Such centers not only act as distribution centers for curriculum materials, they also become centers where many supplementary, audio-visual and fugitive materials can be made available. Such centers are already operating in many parts of the country.

New buildings and modified old buildings should be judged by the effectiveness with which they house current programs, how easily they can be adapted to developing programs and how flexible they are to contain future programs.

Budget -- Organizational Structure -- Communications

Although these subjects are crucial elements of any delivery system, they become the treatment of the three chapters that immediately follow. This is because of their considerable importance.

Appraisal

Appraisal or evaluation is the process of examining all aspects of the educational enterprise to determine its relative efficiency and effectiveness when

- (1) Efficiency is defined as the amount of the product produced and
- (2) Effectiveness is defined as the quality of the product produced.

Because education has always been input oriented, the type of appraisal suggested needs some explanation. The appraisal suggested is output oriented and thus depends upon the definition of the result

expected (the product) and upon adequate measures of quantity and quality. This has been dealt with earlier in the chapter and can be done. The appraisal also makes it essential to take a look at the entire system, state or local, much as was carried out in the school surveys of the teens and twenties of this century but with different purposes in mind. The appraisal suggested would have to deal with governance, with resources, with goals, with all of the factors making up the delivery system and with the product produced. Thus, without going into detail, the appraisal would have to include for governance:

- (1) The establishment of goals, programmable at an appropriate level of the operation, on the basis of which appropriate learning could be produced.
- (2) The furnishing of resources appropriate to the learning needs of the district, if necessary, up to the legal limit allowed the governing board.
- (3) The periodic review of the goals established, delivery system established and the quantity and quality of the result with a view to revision if necessary.

For administrative staff:

- (1) The development and implementation of a delivery system plan to maximize the production of learning consistent with the goals established. The plan would include:
 - (a) selection and training of staff,
 - (b) the allocation of time for learning appropriate to the kinds of programs established,
 - (c) the provision of teaching materials that make possible the measurement of the amount of learning produced but which leave broad discretion to the professional staff for the programming of the materials and the selection of teaching methods,
 - (d) the provision of space appropriate to the programs to be housed,
 - (e) the management of the budget in a way that makes clear the programs and services that are being purchased with the reasons therefore and with specific determination of the cost of the programs and services by item if that is possible,
 - (f) the establishment of an organizational structure that clearly delineates each function and its relation to every other function through the use of job descriptions which makes clear the contribution that each function makes to the production of learning
 - 1) directly
 - 2) on a support basis

3) on an overhead basis

with appropriate weighting for each.

- (g) the primacy of the learning function as first priority responsibility of administration and the management of the delivery system to that end,
- (h) the establishment of a communications system which
 - 1) marshals facts adequately for the purpose of problem solving and decision making, and
 - 2) makes possible adequate interpretation of the learning function of the organization and the results to any person or agency that is interested.

For the teacher:

1. The responsibility for the amount of learning produced and the carrying out of the functions essential to the production of learning assigned to the teacher but subject to the following limitations:
 - (a) goals that cannot be programmed or for which a delivery system cannot be established,
 - (b) resources that are inadequate when the need has been clearly established, the need agreed to and request for funds made
2. The semi-custodial and institutional responsibilities that are assigned as the official portion of the duties which could include:
 - (a) discipline
 - (b) attendance
 - (c) order
 - (d) maintenance of a classroom management structure above the minimum at which learning occurs.

if the duties outlined in (b) are assigned to a specialist, then the duties would not be included in the job description of the teacher.

It is our opinion that the appraisal or evaluation system holds all of the persons involved responsible for their proper performance and is certainly better than the personal traits approach that is so frequently used in public service.

The delivery system chapter has been developed primarily with application to the problem of the local school district. However, if

there is a state interest in appraising the effectiveness of the various districts in the state, the problem becomes a different one. Anyone who has submitted data to the state or federal government, or anyone who has received such data would admit immediately that much improvement could be made. However, if the principles outlined in this chapter for appraisal are followed, it is possible to do state appraisal when the following factors are added:

1. There must be statewide development of learning units with uniform competency standards developed for each unit
2. The units and competency standards must be refined and standardized through field testing by teachers.
3. A cost record system and an aid support system must be developed on a program and services basis.
4. Careful records of the learning expectancy potential of each type of student in the student population must be kept for a period of eight years.
5. Eventually, it will be possible to develop a learning productivity expectancy for each district in the state.

If a national interest develops in educational institution appraisal -- and one may develop on a survival basis -- the same problems and the same procedures would be multiplied by the number of states participating.

Related Research Hypotheses

Hypothesis 1

It is now possible to determine the most effective methods of developing educational materials; i.e., it is possible to develop the total school curriculum program by program in instructional objectives -- small measurable units of learning.

Hypothesis 2

It is now possible to develop for each unit of learning an agreed upon standard of performance on the basis of which the student can be determined to be competent or not.

Hypothesis 3

It is now possible to determine the most effective methods of managing staff.

Hypothesis 4

It is now possible to specialize professional and non-professional staff relating to the functions essential to the production of learning; i.e., diagnosis, pres-

cription, facts and information, skills development, testing, problem solving and decision making (both application and valuing).

Hypothesis 5

It is now possible to write a training manual to train teachers to write, field test, rewrite, sequence, and develop criterion reference measures for instructional objectives.

Hypothesis 6

It is now possible to train or retrain staff at all levels to become highly effective as learning producers.

Hypothesis 7

It is now possible to determine the most effective methods of managing time.

Hypothesis 8

It is now possible to determine the most effective methods of managing space.

Hypothesis 9

It is now possible to do performance appraisal of the educational system based upon contributions to the production of learning.

Hypothesis 10

It is now possible to use the measurable curriculum mentioned in Hypothesis 1 to determine learning productivity expectancies with regard to student age and type of student population, so that after sufficient experience it can be predicted with accuracy how much learning productivity can be expected from each student, school, school district, or state.

Section C

Actions, Proposals, and Discussion from Other States

1. Legislative

- a. Authorize and finance the development of the measurable curriculum utilizing the faculties of local school

districts, after appropriate training of such faculties.

- b. Authorize the State Department of Education to establish guidelines for the specialization of professional and non-professional staff, with authority to allow an appropriate number of districts to try out the guideline plans.**
- c. Authorize the payment of state support to local districts that submit any sort of time allocation plan for their districts as long as the number of hours per year are not reduced.**

2. The State Department could

- a. Monitor the development of instructional objectives collections developed in local school districts in the state and staff the standardization and repository of such collections.**
- b. Allow local school districts to depart from State Department guidelines relating to time and space when indicated by program development or program changes.**
- c. Conduct a staff (plus outside consultant) survey of the delivery systems operating in the state with a view to recommending change where such change could increase learning productivity.**

3. The Local District could

- a. Try out one or more collections of instructional objectives from the state repository, reporting back with appraisal of effectiveness and suggestions for change.**
- b. Develop one or more plans for staff specialization for submission to the State Department.**
- c. Review time and space allocations when programs are developed or revised.**
- d. Review current appraisal systems with a view to giving learning production a maximum emphasis.**

4. Possible Judicial Action

- a. Bring legal action against a local district for failure to conduct appraisal of the delivery system (particularly board and staff) based on contributions made to learning productivity.**

A Public School System
Anytown, Anystate

Code No. 11-05-03-00-00-29
Subject Mathematics
Grade(s) / 5 /
Dist. No. / 29 /
IOX No. - - - -

Major Category: Operations and Their Properties

Sub-Category: Division with 2-Digit Divisors

Objective: Given a division problem with a two-digit divisor the student will find the quotient with or without a remainder.

Sample Items:

Solve the following problems.

- | | | | |
|-----|------------------------|-----|------------------------|
| 1. | $60 \overline{) 435}$ | 2. | $46 \overline{) 447}$ |
| 3. | $89 \overline{) 7158}$ | 4. | $58 \overline{) 558}$ |
| 5. | $68 \overline{) 5432}$ | 6. | $84 \overline{) 6720}$ |
| 7. | $29 \overline{) 174}$ | 8. | $61 \overline{) 253}$ |
| 9. | $35 \overline{) 243}$ | 10. | $57 \overline{) 250}$ |
| 11. | $64 \overline{) 3776}$ | 12. | $26 \overline{) 2208}$ |
| 13. | $39 \overline{) 1722}$ | 14. | $71 \overline{) 6825}$ |
| 15. | $65 \overline{) 5145}$ | | |

A Public School System
Anytown, Anystate

Code No. 11-05-03-00-00-29
Subject Mathematics
Grade(s) / 5 /
Dist. No. / 29 /
IOX No. page 2

Major Category: Operations and Their Properties

Sub-Category: Division with Two-Digit Divisors

Objective: Given a division problem with a two-digit divisor the student will find the quotient with or without a remainder.

Sample Items:

Answers or Criteria:

- | | |
|---------------------|----------------------|
| 1. 7; remainder 15 | 2. 9; remainder 33 |
| 3. 80; remainder 38 | 4. 9; remainder 36 |
| 5. 79; remainder 60 | 6. 80 |
| 7. 6 | 8. 4; remainder 9 |
| 9. 6; remainder 33 | 10. 4; remainder 22 |
| 11. 59 | 12. 84; remainder 24 |
| 13. 44; remainder 6 | 14. 96; remainder 9 |
| 15. 79 | |

COMPETENCE BY PERFORMANCE STANDARD

Classroom Objectives

Objective - Long Division

Number of Test Items	15
Standard for Method	100%
Standard for Computation	85%

This is a measurable unit of learning for one student for one objective.

ORGANIZING, OPERATING, AND EVALUATING THE EDUCATIONAL ENTERPRISE

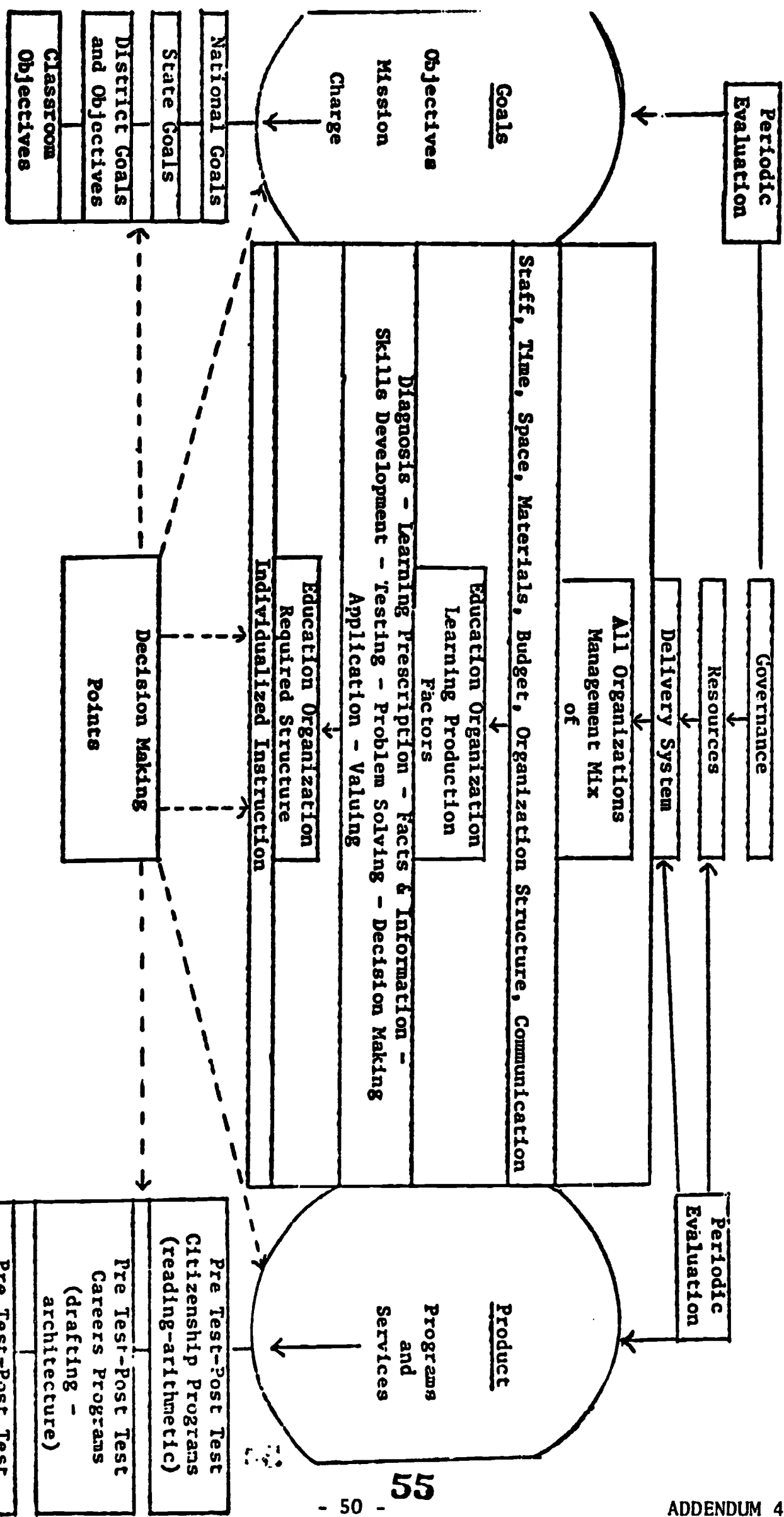

CHAPTER VI

ORGANIZATION STRUCTURE

Section A

Management Principle Five

For All Organizations is

An outline of the structural levels of the organization, describing the various responsibilities by function. (Organization chart -- Job descriptions)

For Education is

An organization made up of people performing the functions that are essential to the accomplishment of the mission. In order to make the relationships clear, the following items must be developed.

1. An organization chart

The organization chart names the functions that are essential to the production of learning and the persons who perform them. It also states clearly the lines of authority and responsibility.

2. Job descriptions

Job descriptions clearly describe the functions performed by each individual in the accomplishment of the mission. The functions could fall into the following categories:

Direct production of learning functions. These would include the function of instruction.

Support of learning functions. These would include such items as library services and the testing functions of a psychometrist.

Overhead functions essential to the productions of learning. These would include the planning, coordination, and appraisal functions.

Section B

Of all of the elements that make up a management system, the structure of organization seems to generate the least interest among managers. This seems to be true in all types of human activity, not only in education. In education particularly, however, organizations tend to reflect tradition and history much more than they reflect planning.

This is unfortunate because the way in which an activity is organized is so important that it can almost determine success or failure by its structure alone. Nonetheless, little literature has been developed in this field, particularly with educational application.

There are two types of organization:

1. formal functional organization and
2. decentralized organization.

The formal functional organization has several characteristics as follows:

- a. for each position there is a short statement of function such as:

Educational Research Service
Elementary Curriculum Service

- b. A rank is given to the function designating its level of responsibility such as:

Division
Branch
Section
Unit

- c. A title is given to the position such as:

Superintendent
Principal
Director
Coordinator
Consultant

No function reports to more than one place and the chain of command is unified. Decisions tend to be made at or close to the top of the organization. Job descriptions tend to reflect tasks and duties.

The decentralized organization has most of the characteristics of the formal, functional organization with the following differences:

- a. Job descriptions tend to become statements of agreed upon objectives

- b. People rather than functions tend to be named because functions are apt to change with periodically agreed upon objectives for a span of time.
- c. At least some of the responsibility for determining the kind of delivery system that will operate in the unit is determined by the head of the unit.

The decentralized organization has developed out of its successful use in industry, notably General Motors and some recently assembled conglomerates. It is interesting to note that while General Motors has delegated rather broad responsibilities, it has always maintained fiscal control in the central organization.

Application in recent years of the decentralized organization structure in education has usually forgotten the corollary that must accompany decentralized delegation of authority without exception. This is the ability to

Hold the unit head responsible for results.

As long as measures of productivity do not exist to the degree necessary to hold the unit head responsible, the decentralized organization will fail to achieve its potential. The key to the future is not in abandoning ideas of decentralized organization, but in developing measures that will make it possible to hold the unit head responsible for results. Until this is done, the head of the organization will tend to retain control of the delivery system because the governing board holds him accountable for responsible operation.

The same lack of ability to hold the unit head responsible for results tends to determine the answer to the controversy over participatory decision making where several individuals jointly make decisions concerning the activities of an organization and consultative decision making where the chief executive or the head of a division consults with many individuals before making a decision but finally makes it himself. If the executive cannot hold the several individuals responsible with him for results, he will tend to make the decision himself. There is some question whether several individuals, a committee or a group can be held responsible for results even if measures of results exist.

There is no reason why the advantages of the formal functional organization and the decentralized organization cannot be combined. There is logic in understanding the continuing functions that are essential to the success of the organization in producing results. There is also some advantage in letting people know the level and limit of their responsibilities, as the formal functional organization does.

There is, nevertheless, considerable point in developing agreed upon objectives and emphasizing the importance of people. Many types of

delivery systems are possible and the flexibility created by decentralization might develop superior ones. The missing link in making successful use of some of the advantages of the decentralized system is in the lack of measures to determine results. The future success of decentralization depends upon the development of such measures. Examples of both types of organizations are appended to this chapter as Addenda 1 and 2.

The development of some decentralization in education has resulted in argument as to whether job descriptions or statement of objectives are better. This will be dealt with in the next section.

Job Descriptions

The use of job descriptions is becoming more common in educational organizations, particularly for school executives. Their use for teachers, however, has not been developed. This creates a considerable problem for the management system, for teachers should be considered a part of the management team as classroom managers. There is some delineation of tasks and duties in the laws of some states, in the school handbooks of some school systems, and in the contracts between boards of education and teachers in other instances; but we have not been able to find much organized attempt to define the teaching function and its relationship to the rest of the management function as developed in related job descriptions. This needs to be done.

Because we have found no job descriptions that include all of the factors that we believe to be essential to an efficient management system, we outline the functions that we believe are necessary. They are:

1. A list of tasks and duties that are common to almost all school executives, including teachers.
2. A method of outlining the responsibility of each executive for the future, for the present and for the past; i.e., his piece of responsibility for the success of the organization.
3. A method of scoring the importance and level of the tasks and duties carried as a responsibility by each executive.
4. A method of establishing priorities for tasks and duties for each executive through the use of agreed upon objectives for each year.
5. The development of measures for the production of learning and for the evaluation of the success with which agreed upon objectives have been met.
6. A system of relating each task and duty to the production of learning with a built-in method of abandoning such tasks and duties if they do not so conform.

A short discussion of each of these six items follows.

BEST COPY AVAILABLE

- a. A list of the tasks and duties that are common to almost all school executives, including teachers.

The list of tasks and duties common to most school executives is as follows; objectives, organization, staffing, facilities and equipment, finance, internal relations, external relations, needs assessment and action research, and programs and services. Examination of the job descriptions included at the end of the chapter will make clear the purpose of each function. Making the establishment of objectives the first responsibility begins to combine the advantages of the formal and the decentralized types of organization. Use of these functions in job descriptions indicates that the functions outlined include all that are performed by school executives in most situations. An occasional executive has no fiscal responsibility, and teachers in many cases do not perform some of the functions. The development of job descriptions that specify areas of responsibility is recommended.

- b. A method of outlining the responsibility of each executive for the future, for the present and for the past, i.e., his piece of responsibility for the success of the organization.

Responsibility for the future can be called planning. Responsibility for the present can be called operation. Responsibility for the past can be called evaluation. An example of such use is taken from the job description of a secondary school principal.

"B. Organization

1. Planning - Develops procedures for:
 - a. the deployment of staff assigned to the building
 - (1) classroom teachers
 - (2) guidance counselors
 - (3) advisers of extra curricular activities
 - b. the assignment of pupils to classes and activities
2. Operation - Administers or consults relating to many procedures which include:
 - a. the assignment and class load of teachers
 - b. the duties of the assistants
 - c. the assignment and load of counselors
 - d. the utilization of the special services staff
 - e. the utilization of time available for instruction
3. Evaluation - Shares in the processes of evaluation of procedures for:
 - a. the deployment of staff assigned to the school
 - b. the organization of area departments of the school
 - c. the organization of the extra curricular department of the school
 - d. the organization of the guidance department of the school"

Actual use of such job descriptions with a school organization indicates that most school executives spend far more time on operations than they do on planning and evaluation. Use of this format tends to give more emphasis to planning and evaluation, a step in the right direction.

- c. A method of scoring the importance and level of the tasks and duties carried as a responsibility by each executive.

It is possible to develop such a scoring mechanism, and one such system has been operating in two school systems for a period of fifteen years. Such a system makes it possible to identify the various levels of responsibility. Natural gaps tend to occur in the scoring ranges making the development of executive classifications much simpler. One sheet from the scoring manual mentioned, and one page from a scoring summary are appended as Addenda 3 and 4.

- d. A method of establishing priorities for tasks and duties for each executive, through the use of agreed upon objectives for each year.

The use of agreed upon objectives to establish priorities works very well. It is obvious that executives will spend more time on some duties than on others, but which ones? An agreement between the executive and his supervisor should resolve most of this difficulty; such agreements are in the beginning use stage in some school districts. If one attempts to combine the advantages of the formal and the decentralized organizations, it should be emphasized that the statement of an objective is not a new duty. It is often a major emphasis, in a given year, of a duty already held. An example from the finances portion of the job description of a superintendent of schools is given:

"E. Finances

1. Planning - Recommends policy to the Board of Education for:
 - a. the annual tax budget
 - b. the annual operating budget
2. Operation - Administers or consults relating to many policies which include:
 - a. the budget as adopted by the Board of Education in accordance with legal requirements, adopted policies, schedules, procedures, accounting techniques and other business, financial, and administrative controls approved by the Board
 - b. a competent system of financial accounting
 - c. competent business and property records
 - d. appropriate records of elections, bonds, and auditing
3. Evaluation - Shares in the processes of evaluation of policies for:
 - a. financial plans
 - b. projected needs for the district
 - c. determining the financial future and security of the district by checking legislative provisions and tax limitations"

A finance objective for a given period of time might be:

"To conduct a successful bond issue and have a second high school ready for occupancy by September, 1972."

Financial responsibility is not a new duty for the superintendent because a fiscal objective has been written. It is simply a very important priority in the financial responsibility already held at a given period in the life of the organization.

- e. The development of measures for the production of learning and for the evaluation of the success with which agreed upon objectives have been met.

It has already been indicated that the most effective measure for the production of learning that has been developed to date is the criterion reference test (performance standard). An example has been given previously. Measuring the accomplishment of agreed upon objectives follows something of a different format except where the responsibility of the executive for the production of learning is direct. When the responsibility is classified as support or overhead the following format could be used.

<u>Direct</u>	<u>Support</u>	<u>Overhead</u>
Objectives	Staffing	Organization
Programs and Services	Facilities and Equipment	
	Finances	
	Internal Relations	
	External Relations	
	Needs Assessment and Action Research	

It is important that the objective be in writing and carefully stated. Most objectives are either accomplished or not. Outstanding accomplishment is also possible. Even where success cannot be stated on a yes or no basis, the agreed upon measures should be stated. The following method of assessing objectives accomplishment is suggestion only.

Objective Appraisal Form

Statement of the objective

Degree of success Failed to accomplish the objective / /

Reasons

Accomplished the objective acceptably / /

Accomplished the objective on an out- / /
standing basis

Measures used

Certification of the Supervisor

Signature

- f. A system of relating each task and duty to the production of learning with a built-in method of abandoning such tasks and duties if they do not so conform.

No such system or method has been developed presently. Nevertheless, if the production of learning can be defended as the primary mission of the educational enterprise, then all tasks and duties should relate to the mission either on a direct, support, or overhead basis. If one or more additional major aspects of the mission are clearly identified, then the examination of the organization and the job descriptions would need to be done in terms of the revised mission. The previous items would then be subject to revision; otherwise, tasks and duties not related to the mission should be abandoned. Examples of job descriptions are appended at the end of the chapter as Addenda 5-7.

Related Research Hypotheses

Hypothesis 1

It is now possible to identify and define the types of school organizations that will contribute most efficiently to the production of learning.

Section C

Action, Proposals, and Discussion from Other States

1. Legislative

- a. Authorize and finance the development of effective management systems through establishing careful

studies of alternative delivery systems for the types of school districts operating in the state. Particular attention should be paid to the types of organization and to the tasks and duties of personnel at the various levels of responsibility.

2. The State Department

- a. Re-examine the organizational structure of the department in the light of the principles and procedures outline in Chapter V with a view to abandoning functions not related to the major mission of the state educational enterprise, or to recommending legislative changes to the same end if that is necessary.

3. The Local District

- a. Re-examine the organizational structure of the local district in the light of the principles and procedures outlined in Chapter V, with a view to abandoning functions not related to the major mission as established by the state and to the goals and objectives established by the local district.

4. Possible Judicial Action

- a. Bring legal action against a local district for the maintenance of teaching and administrative positions unrelated to the major mission of the district as established by the state and the goals and objectives established by the district.

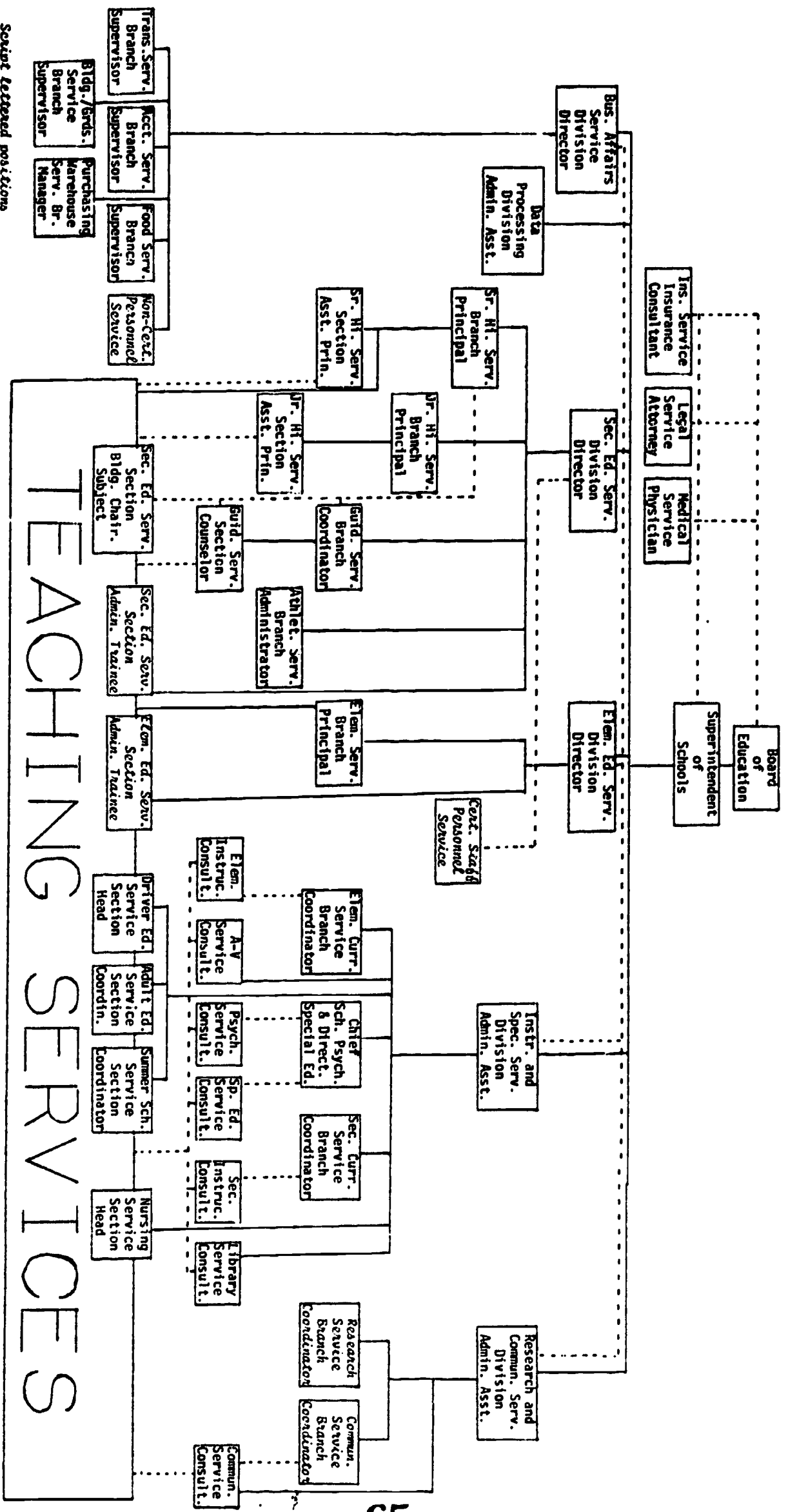

Some of the positions are not established.

TEACHING SERVICES PUPILS



BEST COPY AVAILABLE

DECENTRALIZED SERVICE

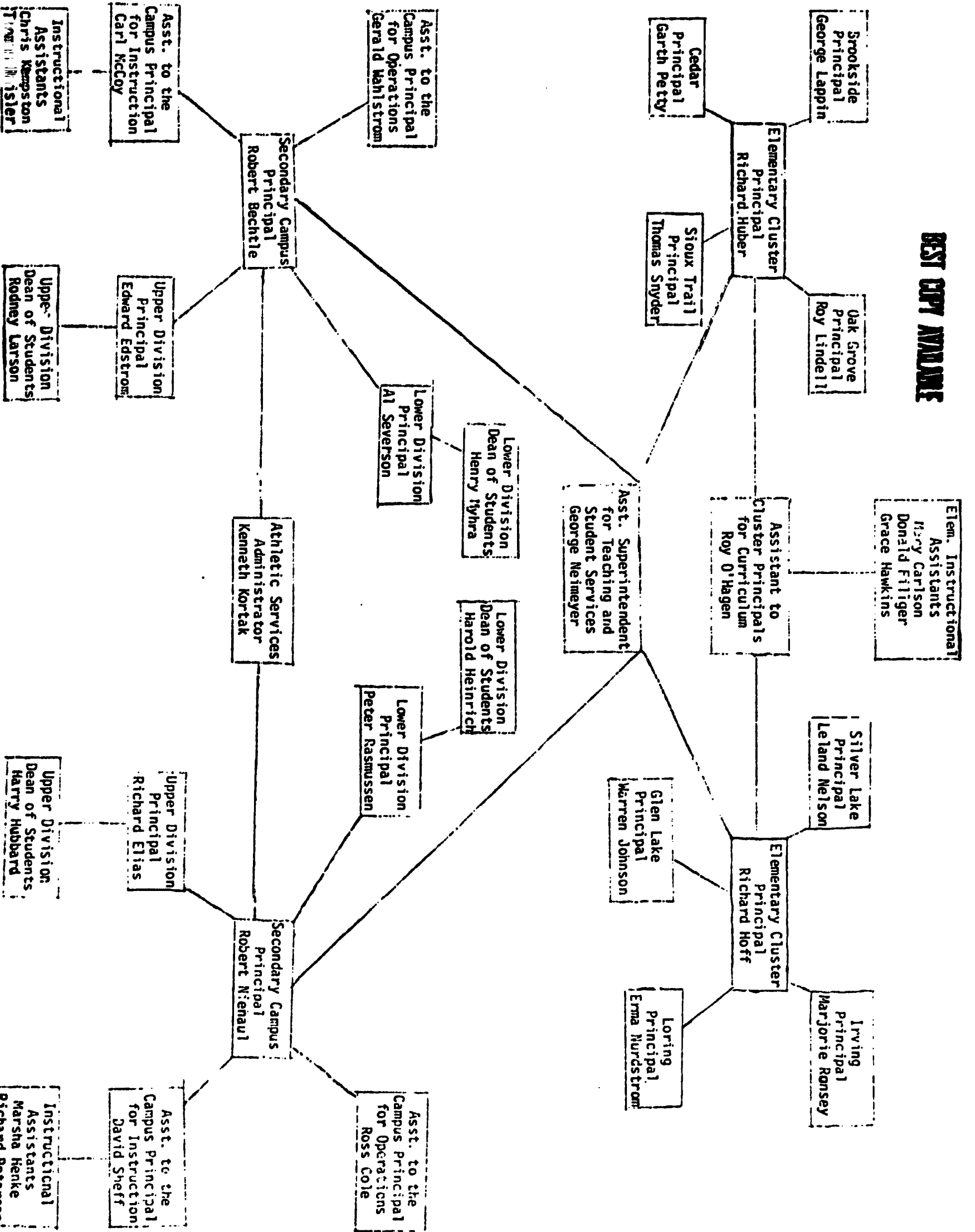

C. STAFFING

2. Operation (maximum points - 1800)

Number of Persons Responsible For

Complexity ↓ Scope	1. Up to 5	2. 6-15	3. 16-35	4. 36-55	5. 56-75	6. 76-100	7. 101-200	8. 201-300	9. 301-500	10. Over 500
1. One simple non-tech. non-prof. program or service										
a. Adm. or consult--few procedures	4	8	12	16	20	24	28	32	36	40
b. Adm. or consult--many procedures	44	48	52	56	60	64	68	72	76	80
c. Adm. or consult--few policies	84	88	92	96	100	104	108	112	116	120
d. Adm. or consult--many policies	124	128	132	136	140	144	148	152	156	160
2. One simple tech. non-prof. program or service										
a. Adm. or consult--few procedures	164	168	172	176	180	184	188	192	196	200
b. Adm. or consult--many procedures	204	208	212	216	220	224	228	232	236	240
c. Adm. or consult--few policies	244	248	252	256	260	264	268	272	276	280
d. Adm. or consult--many policies	284	288	292	296	300	304	308	312	316	320
3. One simple professional or highly technical program or service										
a. Adm. or consult--few procedures	324	328	332	336	340	344	348	352	356	360
b. Adm. or consult--many procedures	364	368	372	376	380	384	388	392	396	400
c. Adm. or consult--few policies	404	408	412	416	420	424	428	432	436	440
d. Adm. or consult--many policies	444	448	452	456	460	464	468	472	476	480
4. One portion--complex program or service										
a. Adm. or consult--few procedures	484	488	492	496	500	504	508	512	516	520
b. Adm. or consult--many procedures	524	528	532	536	540	544	548	552	556	560
c. Adm. or consult--few policies	564	568	572	576	580	584	588	592	596	600
d. Adm. or consult--many policies	604	608	612	616	620	624	628	632	636	640
5. One complex program or service										
a. Adm. or consult--few procedures	644	648	652	656	660	664	668	672	676	680
b. Adm. or consult--many procedures	684	688	692	696	700	704	708	712	716	720
c. Adm. or consult--few policies	724	728	732	736	740	744	748	752	756	760
d. Adm. or consult--many policies	764	768	772	776	780	784	788	792	796	800
6. Several complex programs or services										
a. Adm. or consult--few procedures	804	808	812	816	820	824	828	832	836	840
b. Adm. or consult--many procedures	844	848	852	856	860	864	868	872	876	880
c. Adm. or consult--few policies	884	888	892	896	900	904	908	912	916	920
d. Adm. or consult--many policies	924	928	932	936	940	944	948	952	956	960
7. Several complex programs or services--corr. of like activities										
a. Adm. or consult--few procedures	964	968	972	976	980	984	988	992	996	1000
b. Adm. or consult--many procedures	1004	1008	1012	1016	1020	1024	1028	1032	1036	1040
c. Adm. or consult--few policies	1044	1048	1052	1056	1060	1064	1068	1072	1076	1080
d. Adm. or consult--many policies	1084	1088	1092	1096	1100	1104	1108	1112	1116	1120
8. Several complex programs or services--corr. of unlike activities										
a. Adm. or consult--few procedures	1124	1128	1132	1136	1140	1144	1148	1152	1156	1160
b. Adm. or consult--many procedures	1164	1168	1172	1176	1180	1184	1188	1192	1196	1200
c. Adm. or consult--few policies	1204	1208	1212	1216	1220	1224	1228	1232	1236	1240
d. Adm. or consult--many policies	1244	1248	1252	1256	1260	1264	1268	1272	1276	1280
9. Sev. complex programs or services--adm. corr. or unlike activities										
a. Adm. or consult--few procedures	1284	1288	1292	1296	1300	1304	1308	1312	1316	1320
b. Adm. or consult--many procedures	1324	1328	1332	1336	1340	1344	1348	1352	1356	1360
c. Adm. or consult--few policies	1364	1368	1372	1376	1380	1384	1388	1392	1396	1400
d. Adm. or consult--many policies	1404	1408	1412	1416	1420	1424	1428	1432	1436	1440
10. Administers and coordinates all of Bd. of Ed. activities										
a. Adm. or consult--few procedures	1444	1448	1452	1456	1460	1464	1468	1472	1476	1480
b. Adm. or consult--many procedures	1484	1488	1492	1496	1500	1504	1508	1512	1516	1520
c. Adm. or consult--few policies	1524	1528	1532	1536	1540	1544	1548	1552	1556	1560
d. Adm. or consult--many policies	1564	1568	1572	1576	1580	1584	1588	1592	1596	1600

RESPONSIBILITY SCORES - ADMINISTRATIVE POSITIONS

Factors	Senior High Prin.	Junior High Prin.	Elem. Prin.	Coord. Elem. Curric.	Coord. Sec. Curric.	Coord. Guidance	Sr. High Asst. Prin.
<u>Objectives</u>							
Planning	1764	1284	1038	1524	1524	1044	984
Operation	1196	868	700	1036	1036	700	704
Evaluation	588	428	346	508	508	348	328
<u>Organization</u>							
Planning	1542	1530	1278	978	978	1032	1224
Operation	1188	1180	852	668	668	648	816
Evaluation	414	410	406	334	334	324	328
<u>Staffing</u>							
Planning	762	750	498	522	522	552	42
Operation	1188	1180	852	508	508	688	828
Evaluation	594	590	566	254	254	344	414
<u>Facilities</u>							
Planning	1008	996	984	780	780	744	-
Operation	1184	1176	1016	352	352	656	984
Evaluation	592	588	508	252	252	328	-
<u>Finance</u>							
Planning	1032	1032	786	744	744	732	732
Operation	980	812	648	-	-	488	-
Evaluation	490	406	324	248	248	244	-
<u>Internal Relations</u>							
Planning	1764	1764	1752	1224	1224	1224	1224
Operation	1200	1200	1192	1000	1000	1000	840
Evaluation	588	588	584	408	408	408	408
<u>External Relations</u>							
Planning	1800	1068	1056	926	996	996	756
Operation	1200	712	704	664	664	664	504
Evaluation	600	356	352	332	332	332	252
<u>Needs and Action</u>							
<u> Research</u>							
Planning	1716	1476	996	1236	1236	996	996
Operation	1192	1016	688	856	856	688	648
Evaluation	584	504	344	404	404	324	324
<u>Programs & Services</u>							
Planning	2556	1827	1467	1566	1566	1467	1476
Operation	1794	1302	1050	1014	1014	1014	984
Evaluation	852	609	489	522	522	489	492
<u>Time Period</u>							
Planning	3432	2472	1992	2472	2472	1992	1488
Operation	2368	1728	1408	1728	1728	1408	1008
Evaluation	1144	824	664	824	824	664	496
TOTAL	37,312	30,676	25,540	23,954	23,954	22,538	19,280

68/69

JOB DESCRIPTION

Superintendent of Schools

This is a line position. As the executive officer of the Board, the Superintendent has the following responsibilities:

A. Objectives

1. Planning - Recommends policy to the Board of Education for:
 - a. the development of objectives for the school system
 - b. the development, with principals, of sub-objectives for the various schools
 - c. the development of objectives, through principals and teachers, for classroom management and instruction
2. Operation - Administers or consults relating to many policies which include:
 - a. implementation of Board adopted objectives for the school system
 - b. implementation with principals of sub-objectives for the various schools
 - c. implementation of objectives, through principals and teachers, for classroom management and instruction
3. Evaluation - Shares in the processes of evaluating policies for determining:
 - a. the appropriateness of the school district objectives based on pupil, community, and subject matter needs
 - b. the relationship of the objectives of the various schools to system-wide objectives
 - c. whether or not objectives for instruction are being carried out in classrooms

B. Organization

1. Planning - Recommends policy to the Board of Education for planning an organization to carry out the instructional objectives of the system. The organization includes:
 - a. teaching personnel
 - b. administrative personnel
 - c. special services personnel
 - d. non-certificated personnel
2. Operation - Administers or consults relating to many policies which include:
 - a. maintaining the legal rights of the district
 - b. establishing or altering attendance boundaries for effective placement of students
 - c. providing for transportation of students in accordance with law and with safeguards for protection of the students
 - d. attending all public and executive meetings of the Board except when his own election, tenure, efficiency or salary are being considered. He may be invited to attend such meetings.
 - e. formulating and developing procedures for administration of policy
 - f. assisting the Board in its duty of legislation for the schools

- g. carrying out all constitutional and statutory laws and all charter or state board regulations governing the schools including provisions affecting:
 - (1) issuance of work permits
 - (2) elections
 - (3) bonding
 - (4) auditing
 - (5) required school reports
- h. enforcing the regulations of the Board
- 3. Evaluation - Shares in the processes of evaluation of policies for:
 - a. effectiveness and efficiency of the organization in terms of policy implementation
 - b. increasing effectiveness and efficiency through possible changes, additional staff, etc.

C. Staffing

- 1. Planning - Recommends policy to the Board of Education for a plan for staffing of the various segments of the school district with:
 - a. appropriate compensation plans
 - b. measures of operational effectiveness
 - c. evaluation of the function of the plan
- 2. Operation - Administers or consults relating to many policies which include:
 - a. assigning or altering the assignment, transferring or suspending any or all employees of the Board except himself
 - b. designating other staff members or committees to assist in carrying out the various functions of the organization. In all cases final authority for assignment or change of assignment rests with the Superintendent.
 - c. recommending to the Board where alteration or change in assignment results in change of salary or position title
 - d. providing a method of compensation for each segment of employees in the staffing plan
 - e. administering the compensation plan so that all employees are promptly and effectively paid
 - f. providing a system of administrative position classification to be recognized by the Board
 - g. performing the duties of any officer in the school system in emergencies as executive officer of the Board. This authority cannot be delegated.
- 3. Evaluation - Shares in the processes of evaluation of policies for the staffing plan in terms of:
 - a. effectiveness
 - b. methods of compensation for various classes of employees

D. Facilities and Equipment

- 1. Planning - Recommends policy to the Board of Education for periodic studies to determine:
 - a. housing needs for the total school population at a reasonable load ratio
 - b. equipment needs which will most effectively carry out the instructional plan
- 2. Operation - Administers or consults relating to many policies which include:
 - a. the operation of the various facilities in order that instruction be effectively carried out

- b. facilities properly representing the quality of the district
- c. maintenance of an effective plant
- 3. Evaluation - Shares in the processes of evaluation of policies for determining the:
 - a. effectiveness of the facilities
 - b. obsolescence or depreciation of facilities
 - c. recommendations for remodeling, replacement or improvement

E. Finances

- 1. Planning - Recommends policy to the Board of Education for:
 - a. the annual tax budget
 - b. the annual operating budget
- 2. Operation - Administers or consults relating to many policies which include:
 - a. the budget as adopted by the Board of Education in accordance with legal requirements, adopted policies, schedules, procedures, accounting techniques and other business, financial, and administrative controls approved by the Board
 - b. a competent system of financial accounting
 - c. competent business and property records
 - d. appropriate records of elections, bonds, and auditing
- 3. Evaluation - Shares in the processes of evaluation of policies for:
 - a. financial plans
 - b. projected needs for the district
 - c. determining the financial future and security of the district by checking legislative provisions and tax limitations

F. Internal Relations

- 1. Planning - Recommends policy to the Board of Education for the appointment of:
 - a. advisory councils or committees to aid in the formulating of procedures for carrying on the work of the schools. Membership may be from the school staff and/or community.
 - b. committees from the professional staff including teachers for special purposes. These may be continuing committees in specified areas for the development of recommendations for the solution of problems in the school system.
- 2. Operation - Administers or consults relating to many policies for the development, maintenance, and operation of staff improvement under budget control by:
 - a. approving the reimbursement of school personnel for expenses incurred for attendance at professional meetings
 - b. employing lecturers
 - c. granting temporary leaves from work
 - d. developing professional school library facilities
- 3. Evaluation - Shares in the processes of evaluation of policies for:
 - a. relationships and inter-relationships in the organization, taking cognizance of various factors and pressures on employees from the community, region and nation
 - b. recommendations for improvement of such relationships by working with committees and individuals

G. External Relations

- 1. Planning - Recommends policy to the Board of Education for publicity and public contact by:

- a. representing the school district before the public
 - b. keeping the public informed on activities, needs and successes of the schools
2. Operations - Administers or consults relating to many policies which include:
- a. reporting at each Board meeting such matters as are pertinent to the business at hand
 - b. publishing periodically reports relating to the work of the school system, including recommendations affecting the needs of the system
 - c. attending appropriate sessions of the State Legislature and making known therein the needs of the school district and other related schools in the region
3. Evaluation - Shares in the processes of evaluation of policies for reporting to parents and the community the needs, accomplishments and future of the school district by:
- a. public media
 - b. staff reports
 - c. radio and television programs
 - d. other means
- H. Needs and Action Research
1. Planning - Recommends policy to the Board of Education working with structured research facility to maintain continuous study of the problems of the schools including:
- a. population
 - b. finance
 - c. budget analysis studies
 - d. transportation
2. Operation - Administers or consults relating to many policies which include:
- a. providing to the research division, through reports from staff, board, and community, problems facing the school district.
 - b. working with the research division in the most appropriate method of making studies for the solution of problems
3. Evaluation - Shares in the processes of evaluation of policies for:
- a. the effectiveness of the work of the research division in determining the problems of the district
 - b. application of logic and reason to problems in researching facts and making appropriate recommendations
- I. Programs and Services
1. Planning - Recommends policy to the Board of Education after planning with the directors of elementary and secondary education for:
- a. needs of students
 - b. methodology for providing services
2. Operation - Administers or consults relating to many policies through the principals and instruction division which include:
- a. all programs and services being carried on in the district
 - b. determining gaps in such programs for future consideration
3. Evaluation - Shares in the processes of evaluation of policies for:
- a. new programs and services through appropriate reports to the Board
 - b. traditional programs and services to determine pertinency

FINAL PORTION INADVERTENTLY OMITTED IN PRINTING.



JOB DESCRIPTION

Upper Level Principal

This is a line position. Under the general direction of the Campus Principal, the Upper Level Principal has the following responsibilities:

A. Objectives

1. **Planning - Develops procedures for planning objectives for:**
 - a. the total instructional program of the upper level, including the many elective courses as well as the required courses
 - b. the student activity program including athletics, dramatics, speech, music, and student government
 - c. the program governing student behavior and attitudes
2. **Operation - Administers or consults relating to many procedures to achieve objectives which include working with:**
 - a. staff members individually and in groups on curriculum, instructional materials, classroom procedures, and student activities
 - b. staff members to improve their professional competency
 - c. students and staff members to implement programs designed to develop and maintain desirable student behavior and attitudes
3. **Evaluation - Develops processes of evaluation of procedures for:**
 - a. the total instructional program of the upper level
 - b. the student activity program of the upper level
 - c. the program designed to develop and maintain desirable student behavior and attitudes

B. Organization

1. **Planning - Develops procedures for:**
 - a. the deployment of staff assigned to the building
 - (1) classroom teachers
 - (2) guidance counselors
 - (3) advisers of extra curricular activities
 - b. the assignment of pupils to classes and activities
2. **Operation - Administers or consults relating to many procedures which include:**
 - a. the assignment and class load of teachers
 - b. the duties of the assistants
 - c. the assignment and load of counselors
 - d. the utilization of the special services staff
 - e. the utilization of time available for instruction
3. **Evaluation - Shares in the processes of evaluation of procedures for:**
 - a. the deployment of staff assigned to the school
 - b. the organization of area departments of the school
 - c. the organization of the extra curricular department of the school
 - d. the organization of the guidance department of the school
 - e. the organization of time allotted to instruction in areas

C. Staffing

- 1. Planning - Shares in the development of procedures for:**
 - a. determining specific assignments for which personnel must be recruited
- 2. Operation - Administers or consults relating to many procedures for effective staff utilization which include:**
 - a. assigning teachers to responsibilities for which they are best qualified
 - b. assigning advisers to extra-curricular activities
 - c. delegating duties to the assistants
 - d. managing the entire certificated staff assigned to the building
 - e. developing new programs and activities
- 3. Evaluation - Develops processes of evaluation of procedures for:**
 - a. recommending employees for employment or dismissal
 - b. submitting written evaluation of all probationary teachers
 - c. submitting written evaluations of all teachers leaving the school system
 - d. submitting written evaluations of administrators assigned to the building
 - e. preparing evaluations, as needed, of all certificated staff members assigned to the building

D. Facilities and Equipment

- 1. Planning - Shares in developing procedures for planning of facilities and equipment for:**
 - a. the total instructional program of the school
 - b. the total non-instructional program of the school
 - c. the extra-curricular program of the school
- 2. Operation - Administers or consults relating to many procedures for the operation of facilities and equipment associated with:**
 - a. the instructional program of the school
 - b. the extra-curricular program of the school
 - c. the cafeteria service of the school
 - d. the administrative, counseling and health services of the school
- 3. Evaluation - Develops, under established policy, the procedures for evaluating the use of facilities and equipment in the building**

E. Finance

- 1. Planning - Develops procedures for the expenditure of budgeted amounts of money for:**
 - a. teaching equipment and supplies
 - b. supplementary textbooks
 - c. school activity account
- 2. Operation - Administers or consults relating to a few procedures which include:**
 - a. the supplies budget for all departments of the building
 - b. the equipment budget for all departments of the building
 - c. the school activity account
- 3. Evaluation - Shares in the processes of evaluation of procedures for:**
 - a. textbook and instructional supplies budget for the building
 - b. equipment budgets for all departments of the building
 - c. school activity account

F. Internal Relations

1. **Planning - Develops procedures for:**
 - a. managing and coordinating the entire school program of the building
 - b. maintaining good public relations involving students, teachers, parents, and community groups
2. **Operation - Administers or consults relating to many procedures which include:**
 - a. directing the scheduling, planning, and operation of all curricular activities that extend beyond the classroom (team teaching, field trips, auditorium programs, etc.)
 - b. preparing weekly and daily bulletins of announcements
 - c. directing the preparation of necessary records, reports, and clerical work
 - d. cooperating with assistants in preparation of a master class schedule
 - e. serving as adviser to the building P.T.A. organization
 - f. interpreting the school program to parents and other interested parties in the community
 - g. dealing with serious complaints and criticisms from the community with respect to school policy and the actions of subordinates
 - h. supervising activities of the adviser to the student council
 - i. conferring with students upon request or referral
 - j. sharing of direct supervisory responsibilities during the school day and at evening activities
3. **Evaluation - Develops processes of evaluation of procedures for:**
 - a. the effectiveness of the total school program in the upper level
 - b. public relations
 - c. staff morale
 - d. student morale

G. External Relations

1. **Planning - Develops procedures for:**
 - a. publicity in community and area newspapers, radio and television relating to an extensive curricular and co-curricular program
 - b. publicity in professional publications relating to an extensive curricular and co-curricular program
 - c. Participation in local, regional, and national professional organizations
 - d. participation in local and regional service organizations
2. **Operation - Administers or consults relating to many procedures which include:**
 - a. issuing news releases to the press, radio and television and responding to questions from same
 - b. delivering talks to church groups or service organizations on school-related matters
 - c. participation in local, regional, and national professional organizations
 - d. responding to questionnaires and other legal forms required by state and local government agencies
 - e. dealing with officials from other educational institutions on school visitations, placement of student teachers, interpretation of our school program, etc.

3. Evaluation - Develops processes of evaluation of procedures for determining the accuracy and effectiveness of information about the school program that is given to:
 - a. representatives of the mass media
 - b. other community agencies interested in education
 - c. officials of state and local government
 - d. officials from other educational institutions
 - e. professional publications
- H. Needs and Action Research
1. Planning - Shares in the development of procedures for identifying needs for:
 - a. new subject offerings in an extensive and changing course of study
 - b. an extensive interscholastic and intramural co-curricular program
 - c. personnel services for upper level students
 2. Operation - Administers or consults concerning many procedures which include:
 - a. meeting with staff members individually or in groups to identify needs for an extensive and varied curricular and co-curricular program
 - b. meeting with P.T.A. board and other lay groups
 3. Evaluation - Develops processes of evaluation of procedures for assessing if needs have been properly determined for:
 - a. all area departments in the upper level
 - b. the extra-curricular program of the upper level
 - c. personnel services for upper level students
- I. Programs and Services
1. Planning - Shares in the development of procedures for:
 - a. instructional program: types of courses, methods, curriculum, etc.
 - b. activities program: type of activities, how carried out, etc.
 - c. guidance program
 - d. secretarial services, records, etc.
 - e. health and safety
 - f. parent programs: P.T.A., orientation, etc.
 - g. pupil accounting
 2. Operation - Administers or consults relating to many procedures for:
 - a. the instructional service
 - b. the clerical service
 - c. the custodial and cafeteria services
 - d. the special education service
 - e. the counseling service
 - f. the library and audio-visual services
 - g. pupil accounting records and reports
 - h. the nursing service
 - i. the psychological service
 - j. the transportation service
 - k. the extra-curricular program
 3. Evaluation - Shares in the processes of evaluation of procedures for:
 - a. instructional program: types of courses, methods, curriculum, etc.
 - b. activities program: type of activities, how carried out, etc.
 - c. guidance program
 - d. secretarial services, records, etc.

In addition to the responsibilities as outlined, the Superintendent:

Accepts the power to make such rules and to give such instruction to school employees as may be necessary to carry out the policies of the Board or other instruments or control established by the Board in the management of the schools and in all policy matters not covered by policy shall act on his own discretion where action is immediately necessary. If policy action is indicated, he shall report this activity to the Board for its approval.

Accepts the responsibility for setting aside any such policies as may be necessary in the case of great and sudden danger, disaster, or emergency affecting the schools if, in his discretion, the situation requires it but full details of such action and the reasons therefor and the facts pertaining thereto must be reported to the Board.

Performs such other duties and exercises such other authority as may be required of or conferred upon him by the law or by the School Board.

In addition to the responsibilities outlined above, the upper level Principal performs related duties and accepts responsibilities as assigned or appropriate including management assignments of an emergency nature as designed by the Campus Principal or his designee.

Qualifications

- Educational:** Master's Degree, plus one additional year of graduate training in the field, or a related field, and Minnesota certification.
- Experience:** Five years of teaching or appropriate professional experience, plus five years of job experience or related administrative experience.

JOB DESCRIPTION

Teacher

This is a line position. As a teacher in the school district, the teacher has the following responsibilities:

WHAT SHOULD THEY BE?

CHAPTER VII

BUDGET: COST AND INCOME

Section A

Management Principle Six

For All Organizations is

An accounting of productivity, reporting both quantity and quality of the product on a unit and dollar basis (Output -- preferably computer managed).

For Education Supposes that

If programs have been broken down into units of learning accompanied by performance standards, and if costs have been allocated by program and type of service, the basis for productivity accounting has been established.

The number of units of learning produced in a given period of time can be determined and, in turn, related to the costs of producing them.

The quality of the product produced can be established by the eventual determination of ranges of excellence beyond the minimum performance standard of competency established as the base.

The amount of record keeping essential to this kind of productivity accounting makes the use of the computer eventually essential. To maintain a continuous per pupil record of units of learning that have been completed, that are still available for future study is a task too time-consuming and costly for teachers to do manually. Fortunately, computer capacity has already been developed and computer availability is rapidly becoming a reality for schools.

Section B

The budget is the instrument of fiscal control for a school district. Ordinarily the state establishes categories of budget classification and regulations concerning the expenditures from those classifications. In the state of Minnesota, there is a gen-

eral fund with the following classifications: administration, instruction, health service, plant operation, plant maintenance and fixed charges. Other funds include; capital outlay, food service, transportation, debt service, auxiliary services and federal programs.

In Minnesota, as well as the other states, there has been little misappropriation of funds. Fiscal accountability of schools has been remarkably good. Under the present budget system, school boards, citizens, and taxpayers know

1. how much has been spent,
2. that expenditures have been limited to the budget,
3. that the money has been spent for purposes established by the budget,
4. that they have been protected from misuse of funds,

but

5. they do not know what the money has produced.

Interested agencies will never know what the money has produced as long as money is budgeted in broad categories with inadequate reference to the programs and services that the budget provides. Usually money paid out in state aid is appropriated on a per pupil basis and may be distributed to any classification in the operating budget. An exception is the categorical aid; but these appropriations are seldom for complete costs, and regulations seldom specify that costs include support and overhead costs. If budgets were organized by programs and services, along with productivity measures, the various publics interested in education would know what they were getting for their money.

The problem outlined above has given rise to the development of the PPBS system (for Planning, Programming, Budgeting System). Legislation in five states now requires that school budgets go to such a system. The states are Colorado, Hawaii, Illinois, Indiana, and Ohio. Generally speaking, the legislation in those states requires the budgeting and costing of programs in segregated funds, the budgeting and costing of productivity measures based on goals.

It can easily be seen that PPBS is much more than a budgeting system. It is a reasonably well developed management system, more usually now called PPBES (Planning, Programming, Budgeting, Evaluation System), and is beginning to be called ERMS (Education Resources Management System).

Because there is so much material in educational literature relating to this program, only an outline is presented here:

1. Development of a related chain of objectives from the policy board to the classroom.

2. Establishment of programs and services based on the objectives and manipulation of the variables that the educational establishment controls, such as budget, staff, time, space, and materials.
3. Budgeting for the programs or services for a period of time, usually a year or more.
4. Field testing the program or service in the classroom or other appropriate learning or activity center.
5. Measuring the outcome, either in amount of learning produced or in the number or quality of services produced.
6. Appraising the success of the program or service based on the expectations established in the objectives and adequate measures of them.
7. Revising the delivery system if the expectations have not been met.

See Addendum 1.

If one were to state simply the high priority work that needs to be done if appraisal of the effective use of resources is to be made possible, one would mention the following:

1. The establishment of a few practical goals (outlined in Chapter III) that can be programmed.
2. Understandable outcome measures of the productivity of the programs.
3. Revision of the budgeting and costing system so that the basis is the program or service, carried to the building and classroom level.
4. Evaluation of the degree to which the goals have been met.

In the past two or three years, a measurement development of some interest has emerged, a measurement system called indicators. Indicators have generally been defined as:

Input indicators

describing a condition over which the school has control, such as pupil-teacher ratio, quality of facilities or equipment, number of support services, such as counseling, etc.

Process indicators

relating to characteristics of the educational program, especially the methodologies or structures within which students achieve learning. Individualized instruction would be one such example.

Related Research Hypotheses

Hypothesis 1

It is now possible to determine the most effective methods of managing budget.

Hypothesis 2

It is now possible to establish cost structures so that the input cost of each program offered can be determined.

Hypothesis 3

It is now possible to establish cost structures so that the input cost of each supporting service can be determined.

Hypothesis 4

It is now possible to establish cost structures so that the input cost of each overhead service can be determined.

Hypothesis 5

It is now possible to establish cost data so that the costs of supporting services and overhead services may be appropriately allocated to each program.

Hypothesis 6

It is now possible to arrange state and federal support of schools on a program and services basis.

Section C

Action, Proposals, and Discussion from Other States

1. Legislative

- a. The legislature could mandate the use of budget classifications which would make it possible to determine the costs of the various programs and services offered by the public schools.
- b. The legislature could arrange for state aid to schools to be paid on a programs and services basis.

2. The State Department

- a. The State Department could implement the mandated budget classification system and revise record keeping systems in accordance with it.

3. The Local District

- a. The local district could do test runs of already developed program budgeting systems to get ready for a state system.

4. Possible Judicial Action

- a. Legal action could be taken against the legislature to force budget re-classification and state support on a program and services basis so that an understandable cost/benefit system of budgeting would be initiated.

PLANNING PROGRAMMING BUDGETING EVALUATION SYSTEM (P P B E S)

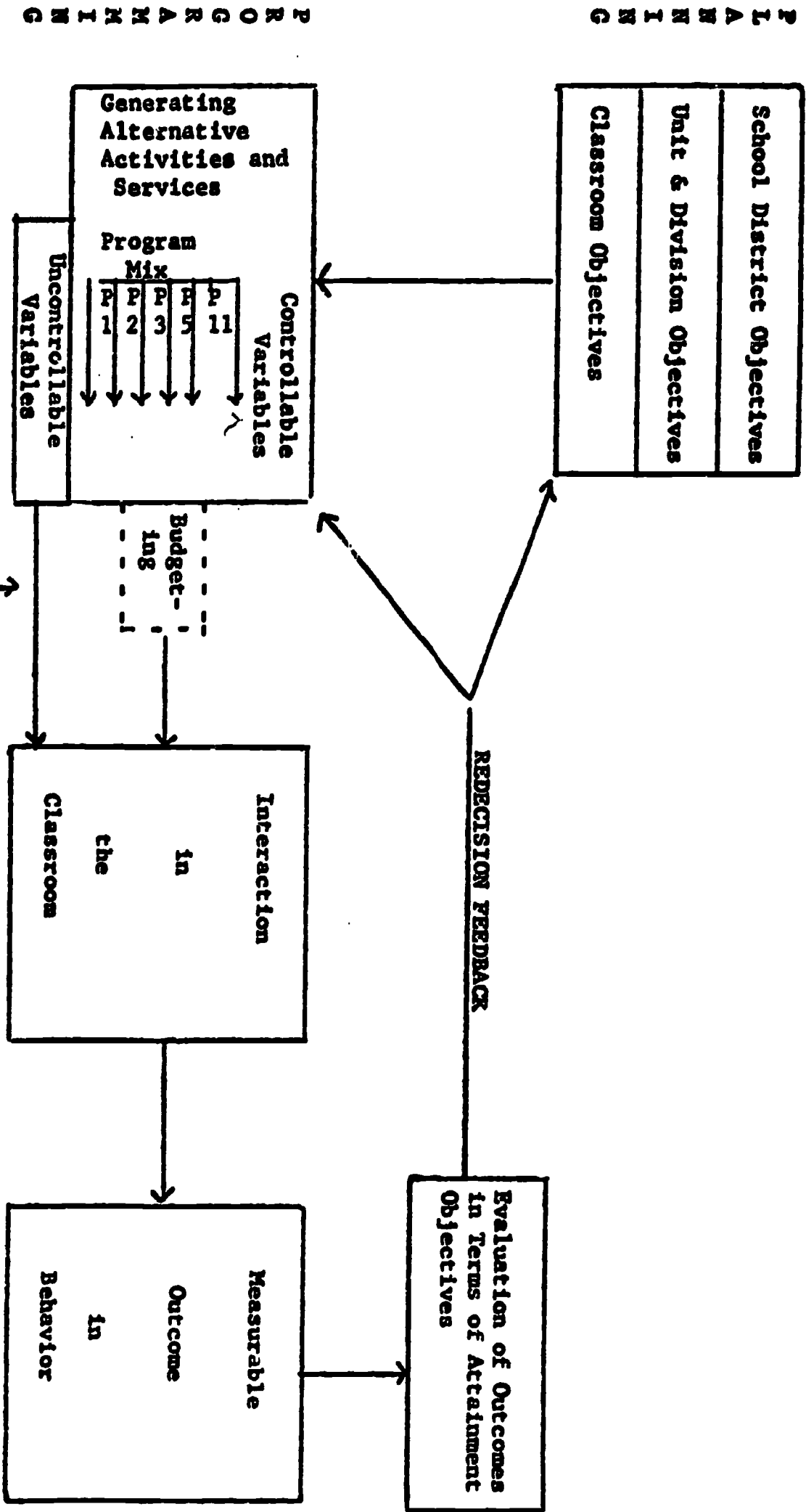

PROGRAMMING

PLANNING

EVALUATION

STATE AID PLAN

Section 1
Priority 1

CONSTITUTIONAL STATEMENT

"Uniform system of public schools. Section 1. The stability of a republican form of government depending mainly upon the intelligence of the people, it shall be the duty of the legislature to establish a general and uniform system of public schools."

Interpretation of Statement Above

General means that specified services and programs are available to all pupils in the state.

Uniform means that a schedule of services and programs defined by the state in terms of input and output requirements, is required of all school districts, and supported in part or in entirety by state funds.

Constitutionally Mandated Subjects

(For Citizenship)

1. Reading
(to a determined performance standard)
2. Arithmetic
(to a determined performance standard)
3. Political Systems
(local, state, national and international)
4. Economic Systems
(in practice, in theory, in the future)

If so determined, this program could constitute the "general and uniform system of public schools."

Finance

100% State

STATE AID PLAN

Section 2

Priority 2

INNOVATIVE PROGRAMS

By Application:

Finance

State Appropriation

STATE AID PLAN

Section 3

ADDITIONAL NECESSARY PROGRAMS AND SERVICES

Section I, though constitutionally required, does not include all of the programs and services essential to effective participation and involvement in today's world.

For Careers

Legislature could require 24 additional programs and services; 12 required by the State Department, 12 selected by the local district.

State Department Required	Local Board Selected
<p>Possible Examples:</p> <p>Program Career opportunities in the state</p> <p>Service Transportation</p>	<p>Possible Examples</p> <p>Program Agriculture</p> <p>Service Nursing</p>

Finance

Complete Equalization
State Participation 0 to 99%

STATE AID PLAN

Section 4

Priority 4

ADDITIONAL POSSIBLY DESIRABLE BUT OPTIONAL
PROGRAMS AND SERVICES
(For Personal Development)

Any local school board may provide any of the programs and services not already selected in Sections ~~2~~ at complete local cost and by referendum.

2+3

X

Examples:

Music
Art
Physical Education

Exceptions to Finance Statement

Exception 1. A flat grant of 50% of the cost of a given program or services shall be made to any district so selecting by referendum if the adjusted assessed valuation per pupil unit is below the 20th percentile on a state-wide basis.

Exception 2. Any district not eligible for grants may levy the same number of dollars for programs and services in Section III without referendum as is received in grants by any school district eligible in Exception 1.

**SELECTION LIST
PROGRAMS AND SERVICES
(EXCLUDES CAFETERIA AND OVERHEAD)**

Curricular

1. Language, Handwriting, Spelling, Library, 1-6
2. Communications Skills, 7, 8, 10, 11, 12
3. Elective Communications, 10, 11, 12
(Speech, Debate, etc.)
4. Advanced Writing and Speech, 11, 12
5. American History, 10 or 11
6. American Social Problems, 12
7. Elective Histories, 10, 11, 12
(World, African, Asian)
8. Geography, 8
9. Advanced Placement History, 12
10. African or Asian Studies, 11, 12
11. Elective Mathematics, 9, 10, 11, 12
12. Advanced Math, 11, 12
(Calculus, College Algebra
and Trigonometry)
13. Computer Math & Data Processing, 10, 11, 12
14. Science & Conservation, 1-8
15. Upper Level Sciences, 10, 11, 12
(Biology, Chemistry, Physics)
16. Elective Sciences, 10, 11, 12
(Astronomy, Physiology,
Physical Science, Aerospace)
17. Advanced Sciences, 11, 12
(Enriched Physics, Great Ideas)
18. Psychology, 11, 12
19. Physical Education, Health, & Safety, 1-10
20. Advanced Physical
21. Driver & Safety Education, 9, 10, 11, 12
22. Fine & Practical Arts, 1-8
23. Performing Arts, 10, 11, 12
(Drama, Band, Choir, Orchestra)
24. Advanced Art, 11, 12
25. Introduction to Foreign Languages, 9, 10, 11, 12
Advanced Foreign Languages, 10, 11, 12 (III-IV)
26. Business Education, 10, 11, 12
27. Advanced Business Education, 11, 12
(Marketing, Business Law)
28. Office Education, 11, 12
29. Trades & Industries, 11, 12
30. Distributive Education, 11, 12
31. Home Economics & Industrial Arts, 7-8, 10
32. Advanced Home Economics & Industrial Arts, 11, 12
33. Vocational Education, 10, 11, 12

Co-Curricular

1. Athletics
2. Stage Productions
3. Speech Activities
4. Publications
5. Clubs & Organizations
6. Adult Education

Services

1. Health
2. Speech Correction
3. Psychologist
4. Police Liaison
5. Tutorial
6. Homebound Instruction
7. Library & Audio-Visual
8. Social Work
9. Occupational Therapy
10. Special Education
11. Guidance Program
12. Transportation

CHAPTER VIII

COMMUNICATIONS

Section A

Management Principle Seven

For All Organizations is

A data-based communications system (preferably computer managed), rooted in logic and reason, adequate to the task of:

1. assisting in the problem solving and decision making, and
2. making possible adequate reports of productivity to appropriate interests

For Education involves

Information storage and retrieval systems. Data does not make decisions. However, data, if properly marshalled, can be of major assistance in problem solving and decision making. Our records are becoming better for populations, for buildings, for budgets, for inventories, for teacher training, for schedules, and for many other items. Unfortunately none of these data can be as significant as they should be without data relating to learning productivity. The amount of learning produced is the only way in which decisions can be made effectively concerning the appropriate allocation of resources.

The methods used by the educational establishment to report to its various communities of interest have never been completely accepted nor understood. In recent years, partially because of increasing cost, the methods have become less acceptable. Students, parents, taxpayers, boards of education, and legislatures have expressed their dissatisfaction in various ways. If learning productivity were determined, reports to all of these groups would be improved. Reports would then be:

1. Consistent with the mission of the organization

2. A basis for further support
3. Simpler
4. More acceptable
5. Easier to provide (if computer managed)

Section B

Problem solving and decision making face all organizations. The private sector is concerned with effective management of the delivery system for productivity of goods and services that will lead to a profit. The public sector is even more concerned, for it deals with more communities of interest and does not have profit as a simple measure of productivity and efficient operation. Whether public or private sector, the fuel for problem solving is information. Part of the problem that public schools face in information storing and retrieval is the problem of what information is pertinent. Because of the confusion presently existing relating to goals, delivery systems, measurement, and costs, it is very difficult to know what information will lead to a good decision when a problem is faced. To complicate the matter, until recently all school administrators faced a paucity of all information; most school administrators still do. In most school systems, all information is manually stored and manually retrieved. Every administrator of any experience has lived through the trauma of vital information being lost in the files.

A vice-president of an international company has stated repeatedly that the president of his company has more information every day about the productivity of his organization than any superintendent of schools does in a year.

Through TIES (Total Information for Educational Systems), the schools of the Twin Cities metropolitan area are compiling better information about school populations, buildings, budgets, payrolls, inventories, teacher training and assignment, programs and program assignment. Through MECC (Minnesota Educational Computing Consortium), the state will eventually have a regionally coordinated computer service that will make such general services available to all school districts in the state. When this is done, the only limitation upon effective problem solving and decision making will be the ability of the decision maker. However, until the problem solver and decision maker knows the amount of learning that the organization produces, his allocation of resources will leave something to be desired. If the decision maker follows the management principles that have been outlined up to now, decisions should be greatly improved.

On a broader than district or state basis, the past six years has seen the advent of ERIC (Educational Resources Information Center) which scans the items for ERIC Descriptors and produces references on requested topics by printout. The cost is modest and provides a national source of information to assist research, report practice, and guide innovation.

If the principles are followed, another advantage will be gained. School personnel will be able to report to students and to parents how much learning has been produced over a period of time and in what areas. With minimum performance standards established and qualitative levels of performance established above them, the reporting would be better than anything that is being done now. One reason is that marking systems or reporting systems up to now have been as varied as the people who have used them. No matter whether the system is A B C or numerical grades or periodic reporting on an essay basis, every teacher has his own method and his own value system. The answer to the question, "I want to know how my kid is doing," has been as varied as the teacher population. Learning units and performance standards should be an improvement.

Again, in this development, the use of the computer is a must. With the number of learning units that will eventually be in use, the computer is the only storage and retrieval system that is practicable. Most educational computer service systems have the capacity and the staff to provide this service. TIES has made a start with CAM (Comprehensive Achievement Monitoring) a Title III project. Such reporting could have a brilliant future.

Learning productivity measures would also make reporting to other agencies much more meaningful. School Boards could get accurate, periodic reports of the productivity of the school district. Legislature and taxpayers could be made aware of the effectiveness with which resources allocated to education had been used at the local district level and at the state level. Certainly the possibility of further financial support would be enhanced by such reporting. In addition to simpler and more acceptable reporting which would be easier to provide, education authorities could tell for the first time the degree to which the major mission of the institution was being accomplished along with an appraisal of the completion of accompanying goals and objectives. Such a result would certainly be greatly to be desired.

Related Research Hypotheses

Hypothesis 1

It is now possible to develop a data bank communication system to assist in problem solving and decision making.

Hypothesis 2

It is now possible to develop a data bank communication system to assist in results interpretation.

Section C

Actions, Proposals and Discussion from Other States

1. Legislative

- a. The Legislature could authorize and fund a state wide, regionally based, language compatible computer system to assist in problem solving, decision making and results interpretation.

2. The State Department

- a. The State Department could establish the plan, design the services to be provided and request the funds from the Legislature.

3. The Local District

- a. The local district could organize its records so that they were available on a maximum basis locally, and standardize where necessary so reports could be made to the state on a comparative basis.

CHAPTER IX

THE EXPECTED RESULT

If the seven management principles have been followed, the local district and/or the state will have:

- A. Stated the major mission of educational institutions and developed appropriate goals and objectives after testing for practicality.
- B. Defined learning if that is the major mission of the institution, identified it as the expected product and defined the functions essential to its production. Established reasonable measures to determine the amount of learning produced.
- C. Re-examined the elements of the delivery system, marshaled to produce learning, to provide maximum proficiency in the use of resources to accomplish the mission. The elements are educational materials, personnel, time, space, budget, organization structure, communications and appraisal.

With these matters accomplished, the local district, and/or the state will be able to make refined judgments concerning many items that are now less possible, such as:

- A. The development of new programs

New programs will only be developed if they are required by the stated mission or adopted goals. Exceptions could be the development of innovative programs looking to new approaches to old goals or exploration of goals yet to be established. Measures to evaluate the new programs will be built in, a matter which is now less possible.

- B. The abandonment of programs

If a program is not required by the mission or an adopted goal, it should be abandoned.

- C. Improvement of programs

If a program is associated with the mission or an adopted goal, but is not accomplishing the purpose, based on results, the program would have to be revised and the delivery system changed. If no delivery system can be devised for a worthwhile goal, the goal will have to be abandoned, or the matter placed under study for possible delivery system development.

D. School services

The same judgments already outlined in A, B and C could be made with regard to school services.

E. Cost

While the cost of producing units of learning in a given program should not determine its future, the ability to determine such cost would certainly help in establishing and reviewing priorities.

F. Interpreting Results

With results information available for all programs, ability to interpret the efficiency and effectiveness of the institution would be greatly enhanced. These advantages would be found in interpreting to students, parents, taxpayers, school boards and legislatures.

The above improvements have dealt with the results or products of the educational enterprise. Judgments are also improved when the process engaged in by the institution is examined. Improved process judgments include:

A. School personnel

When the personnel of a school is dealt with primarily in terms of contributions to the production of learning, instead of on the basis of personal traits, personnel decisions become both easier and fairer. Judgments relating to personnel involve decisions to:

1. retain
2. re-train
3. reassign, or
4. terminate

B. Individualizing instruction

Creating flexibility in the management of the delivery system makes it possible to accomplish the most important process in education, the true individualization of instruction. A frozen delivery system makes individualization impossible.

C. Humanizing education

Much has been said about humanizing the educational process. Nothing can humanize education as much as individualization of instruction. A learner, learning with programs uniquely designed to serve his needs and the needs of society has received the maximum in humanism that the school can provide.

A Final Word

If the production of learning is not the mission of the educational institution, or if other missions in addition to it are established, the management principles previously outlined do not change. The procedures still involve:

- A. The careful development of practical goals
- B. The management of delivery system elements to accomplish the expected result, and
- C. A definition of the product expected, accompanied by measures of efficiency and effectiveness.

The total dialogue about the management of education must begin. Without such dialogue we face the fruitless arguments in which principle is pitted against strategy, budget is opposed to learning, and goals are unrelated to the school's accomplishments. All seven management principles must be applied and interrelated.

It is our firm belief that we have the skills and the instruments at hand to make the management system work, now. This way must lie the future.

APPENDIX A
IMPROVING MINNESOTA EDUCATION
An Introduction to Management Systems

Regional Clinics

Duluth, May 6, 1974

Mankato, May 9, 1974

St. Cloud, May 14, 1974

Foundation for Minnesota Progress

IMPROVING MINNESOTA EDUCATION

Regional clinics entitled "Improving Minnesota Education" were held in Duluth, May 6; Mankato, May 9; and St. Cloud, May 14. Five representatives from each of 15 interested organizations were asked to send delegates. The Executive Director of the Foundation for Minnesota Progress, Dr. Spencer W. Myers, made a forty-minute presentation using transparencies outlining a management system to improve Minnesota education and create accountability. The presentation followed very closely the outline of a management system included with this report as Appendix A. After discussion group activity, group chairmen and observers made two-minute reports. The questions and comments reported as well as the comments of the presenter are a composite of all three conferences.

I. THE MANAGEMENT SYSTEM Comments and Questions

1. Isn't a management system awfully complicated?
2. Shouldn't we fear an imposed management system?
3. What would happen to special education if we used a management system?
4. Isn't a management system mechanistic -- a business model which is bad for human beings?
5. Wouldn't a management system put children into just one group?
6. It's good, how do we get started?
7. What happens to the affective domain if we use a management system which depends on measurable units of learning and competency standards?
8. What about the procedure of valuing -- isn't this an important function for the schools?
9. It must be a plus that no one has disagreed concerning the hoped for results of a management system applied to education.
10. Education is a process and not a product and, therefore, a management system will not work.
11. It would seem that what we are suggesting here is change for change's sake.

COMMENTS OF THE PRESENTOR

No management system applied to education can be less complicated than the problem it attempts to solve. If we are going to successfully measure the results of the efforts of the educational enterprise and use resources to maximum effectiveness, the management system will have to have several parts.

The question raised with regard to special education is a good one. Standards and expectancies relating to exceptional children would be different than they would be for normal children, but the elements of the management system would be the same.

No management system would need to be imposed if the current system were accomplishing the results we hope can be produced through the

educational process. Ideally, a management system cooperatively developed by the education professions and their interested clientele would be the ideal way to go.

A management system is neither mechanistic nor humanistic. It is simply a means of planning for anticipated results through organization.

A management system would not tend to put children in just one group; indeed, it would tend to do the opposite. The tendency now is to put children into just one group. We would hope that effective planning through a management system would result in far more individual treatment for children than they now receive.

The question about the affective domain is an important one, and no one denies the importance of attitudes, feelings, and emotions. The question is when one examines the problem carefully, "can the educational enterprise do anything about the affective domain?" One test would be to apply the following steps to a change in attitudes procedure.

1. Carefully define the attitude that is to be changed.
2. Outline step by step the teaching strategies to be used to change it.
3. Outline one or more bench marks which show that you are moving the child from where he was to where you want him to be, and
4. Establish measures showing accomplishment of results.

In the affective domain the procedure is the same as it is in other domains; namely, the establishment of a definable goal, the development of a delivery system to do something about it, and a measurable product.

Whether or not we are suggesting change for change's sake depends on whether or not education in Minnesota and the United States is facing a problem serious enough to require some change. It is our opinion that we are. It is probably the tendency of all bureaucracies to prefer the status quo for status quo's sake, rather than change for change's sake.

Education certainly involves a process as does all human endeavor. In our opinion, it also involves product, which is learning produced. The problem that develops with some alternative and open schools is that they are completely involved with process and not with product at all.

The question relating to valuing is an extremely important one. There is a very important school function called valuing. It is proper to assume that valuing is based on competent knowledge of facts and competent knowledge of skills first.

It is probable that some valuing cannot or should not be measured, but this is no reason for not measuring the composition of facts and skills upon which valuing is based.

II. GOALS

Comments and Questions

1. There is an old principle -- the less government, the better. Therefore, we should have only local goals.
2. Goals are fine as long as we don't have to work with them for an outside agency.
3. Goals are useless if classes are too large.
4. Are you for training children or educating children?
5. What if you don't need a goal or an objective?
6. Are we sure about goals in education?
7. State goals would be too rigid -- does the state have the right to set goals?
8. Who determines what the goals should be?
9. Isn't it pretty difficult to wait until the citizen matures to see if the school has done its job?
10. Shouldn't goals vary by area?

COMMENTS OF THE PRESENTOR

Class size has really nothing to do with effective goals or ineffective goals accomplishment. Coleman report conclusions seem to indicate that class size has little or no effect upon the amount of learning produced.

In our opinion, attempting to differentiate between training for children and education for children is not a useful exercise. There is no second-hand training or education for children, only inappropriate training or education. Either training or education, however defined, are only appropriate when they relate directly to agreed upon goals.

Perhaps we don't need goals or objectives, but as someone once said, "When you don't know where you are going, all roads are the same."

The state does have a right to set goals because all legal decisions that we know about make education a state function. Whether state goals would be too rigid or not would depend upon the effectiveness with which they were developed. Local input into state goals establishment is perfectly feasible and might solve the problem.

Goals can be determined in any number of ways, but in today's world, input from school boards, administrators, teachers, parents, and pupils would seem to be appropriate.

It would be difficult to determine that the school system had or had not done its job by an examination of the graduates of the schools "x" years later. So many other impacts would have been operative by then it would be impossible to measure the effectiveness of the school at that time. Measures of school effectiveness in the accomplishment of goals is probably much more short range; that is, while the student is going to school or not more than a year or two afterward.

In our opinion, some goals really should vary by area. Here we believe that career goals and personal development goals might vary. About goals in which the state as a political subdivision has a stake,

one might have a different opinion. It could very well be that the ability to read to a minimum performance standard, the ability to do arithmetic to a minimum performance standard, and the acquisition of knowledge concerning political and economical systems might be required of all students as minimum citizenship skills. In fact, this may be the answer to the problem of defining the meaning of a "general and uniform system of public schools," the statement found in the Minnesota constitution.

III. LEARNING AND THE FUNCTIONS ESSENTIAL TO ITS PRODUCTION Comments and Questions

1. How do we define learning?
2. If we defined learning and the functions essential to its production, would it be helpful in interpreting education to its various publics?

COMMENTS OF THE PRESENTOR

We are currently defining learning as "quantifiable changes in the behavior of the learner attributable to the school." We do not defend this definition as the final word. We do strongly suggest, however, that if producing learning is the essential function of the school, then the education professions and their interested publics must come to a common understanding of what learning is .

Defining learning and the functions essential to its production would most certainly assist in better understanding of what learning is.

IV. DELIVERY SYSTEM Comments and Questions

1. Development of the curriculum and the measurable units of learning accompanied by the competency standards was felt to be unnecessary in some areas, if it was necessary in any.
2. The development of instructional materials following this format would be teaching for testing which we would resist.
3. How do you arrive at curriculum -- do you buy it or build it?
4. What level of math and reading would be acceptable?

COMMENTS OF THE PRESENTOR

The development of measurable units of learning and competency standards is necessary for accountability. Use of this kind of instructional material is the best way we know at the present time to establish some measure of the amount of learning produced.

Teaching to the test is only bad under two sets of circumstances:

1. When the test is a broad sample of what is generally taught, but not necessarily what is actually taught to any group of children, and
2. If teaching to the test would result in paying someone for results that were not representative of the specific elements in the curriculum.

If the test is a measure of what has been agreed children should learn, then there is nothing wrong with teaching to the test.

Curriculum materials can be either bought or built by each individual classroom, each individual building, each individual school district, or each individual state. It should be understood that materials built at any level can only be accurately measured at the level at which it was built. If we want to measure learning produced more broadly than the individual classroom or the individual building or the individual school district, the materials developed would need to be common to the entire area. This would seem to be a reasonable approach. We certainly do not expect that textbooks be developed by each individual classroom, or each individual school, or each individual school district.

Competency standards for math and reading should be cooperatively developed by teachers, but once developed, should be insisted upon with minimum competency standards for all students except special education students.

Delivery System Personnel Comments and Questions

Cooperative training in the uses of a management system would certainly be a plus for the smaller district that probably could not afford to do this for themselves.

COMMENTS OF THE PRESENTOR

This was the only comment which was related to inservice education for personnel. In our opinion, the whole success of the development and use of a management system depends on intensive inservice education and retraining of teachers, administrators, and board members with some emphasis on establishing new understandings for students and parents as well.

V. MEASUREMENT Comments and Questions

1. How do we measure learning?
2. Isn't this proposition the State Board Examinations all over again?
3. You can't computer measure humanism, can you?
4. Is it the job of education to produce children, citizens for the future, learning, or what?
5. How do you measure art?
6. How do you measure human relations?
7. Can you measure intangibles?
8. Can you measure every goal?

COMMENTS OF THE PRESENTOR

Learning is admittedly difficult to measure, but the most helpful development at the present time is the careful definition of units of learning along with a competency standard for each one so that one can tell when a student has developed a minimum competency in the unit. It

is our opinion that the proposals that we are making are very different than the State Board Examinations. State Board Examinations are adaptations of national norm tests. It is only by accident that the examinations become measures of what is actually being taught in an individual school. When instructional objectives and competency standards are used, the criterion reference tests become specific measures of what has been taught.

It is admittedly more difficult to measure some things than others and some items can be more accurately measured than others. We would be the first to indicate that you cannot measure what you cannot define carefully in the first place. Humanism and human relations suffer from this problem. It is true that unless you can define an item such as humanism carefully, you cannot teach it.

The question as to what education is supposed to produce is a good one because it does relate to the confusion that commonly exists in most school districts in defining the mission of the educational enterprise. While final decisions regarding the mission of the educational establishment should probably be done on a broad involvement basis, the simple answer for us is that the mission of education is to produce learning.

It certainly would be true that most goals presently stated for education cannot be results measured. Many feel that this is a criticism of the method of goals establishment rather than the process of measurement. It has been suggested that unless a goal can be programmed, the results measured, and the costs for completion determined, the goal should not be stated. Some goal statements could be modified by indicating that this was:

- a) a goal to be considered in the future, or
- b) a goal to be identified for possible study.

VI. COMMUNICATIONS

Comments and Questions

1. I don't think we really know how to use the computer.
2. I believe the computer has failed in
 - a) dating programming
 - b) approaches to feelings and attitudes, and
 - c) Westinghouse learning
3. You suggest more individualization but then try to make children the same by putting them into a computer.
4. The use of a computer is essential, and we will use it increasingly in the future.
5. If you can define and describe an item, you can use the computer to measure it.
6. The computer is a valuable tool for assisting in the making of educational decisions at the administrative level.

COMMENTS OF THE PRESENTOR

It is very true that many people do not understand the proper use of a computer; in fact, are afraid of the instrument. The computer has failed whenever its use has exceeded its proper ability to store and re-

trieve information. This is the use we are suggesting for it; that is, the many facts relating to the school enterprise be stored in the computer so that when facts are necessary for educational decision making, they can be immediately retrieved. Secondly, if we use the computer to record the number of units of learning that each student has accomplished to a competency standard, we are using the computer properly. This also becomes the answer to the feeling that when we use the computer, we make children uniform. What we are actually doing is the reverse; we are keeping records adequately for the first time of their individual accomplishments. Thus, the computer helps us actually accomplish individualization.

VII. PROGRAM BUDGETING

Comments and Questions

1. There is a great deal of interest in program budgeting.
2. We will know a great deal more about our productivity if we use program budgeting than if we receive our money and establish our budget on a per-pupil basis.
3. Does education have a problem with dollars?
4. Are we dealing with dollars or children?

COMMENTS OF THE PRESENTOR

There is a problem of dollars, and unless there are changes in the next session of the legislature, school districts representing 50 percent or more of the children in the state will be cutting budget, some quite severely. There is no way to avoid dealing with both dollars and children. The great appeal that children have will not save us from difficulty unless we deal with dollars as well.

VIII. GENERAL COMMENTS

The following general comments might be made of all the regional conferences:

By far the greatest amount of interest was generated in the area of goals establishment. There was wide divergence of opinion about what the goals should be, who should establish them, and how they should be administered. Because goals establishment is an early and absolutely essential step in the development of an effective management system, it was felt that this discussion was quite useful.

The least interest was shown in the area usually included in a management system entitled "Structure of Organization." This lack of interest is not unique to the educational establishment. It seems to be common to all types of organizations whether they be educational, business, military, or religious.

By far the most controversy was created in the discussion of learning productivity and its measurement. There was major disagreement as to whether or not either the quantity or the quality of learning produced could be measured and a great deal of time was spent discussion such items as attitudes, creativity, motivation, and affective domain items.

It was evident to all that to raise and discuss the major issues required far more time than was given. It became evident and was generally agreed that the various interested agencies and organizations would need to spend a great deal more structured discussion time before the problems of educational improvement and accountability could be resolved.

Because the management system mentioned has been discussed in detail in the report entitled "The Future Management of Education," it is not included here.

APPENDIX B

This issue paper on a management system for education is one section of a report submitted in September 1974 to the Minnesota State Board of Education by a School Finance Task Force chaired by Dr. Van Mueller of the University of Minnesota.

ISSUE PAPER - EDUCATION MANAGEMENT SYSTEM

Education at all levels is being challenged by the citizenry to be "accountable". The system is increasingly called upon to explain the outcomes expected from a public school education and to document expenditures of public funds. School boards and administrators must make decisions vital to education but sometimes to do so with a less than adequate long-range plan or information base. The problem may be viewed as one of identifying the expectations of education, preparing well-conceived plans, and establishing a system for program implementation. In summary, Minnesota has need for a clearly defined education management system.

SUMMARY

The Minnesota Constitution charges the Legislature with establishment of a "general and uniform" system of public school education. Throughout the history of this state (and of most other states) this system has never been thoroughly defined. Some recent attempts at this program definition have been inaugurated by the State Department of Education and by the executive branch of state government but these have been less than fully successful. This failure leaves educators without a clear delineation of the ultimate goal toward which they must strive.

In the absence of a direct Legislative mandate, state and local agencies have not fully established a comprehensive system of goals and objectives nor have they clearly defined standards of educational performance. Numerous efforts at goal setting have resulted in an incomplete, non-comprehensive plan for education in the state. This process is further complicated by the fact that the schools must adjust accordingly as social and economic conditions change. Thus is needed a flexible state-local educational system which is expressly designed to provide students with the skills to function effectively as well-rounded, responsible, and productive citizens in the years ahead.

Establishment of a management system for education cannot be accomplished on a random, haphazard basis. School personnel, particularly those with a management responsibility, must be trained in the use of management tools. Where this skill does not exist, the state must be prepared to encourage and support necessary training and re-training.

RECOMMENDATIONS

1. The Minnesota Legislature should assume responsibility for defining the purposes, philosophy, and general goals of education for the State.

In accomplishing this task, the Legislature should have involvement of the Department of Education, school administrators, school boards, teachers, and the general public. The outcome should be a framework for definition of the Constitutional provision for a "general and uniform" system of education.

2. The State Board of Education should be delegated responsibility for carrying out the Legislative educational mandate and for establishing goals, objectives, and standards necessary to the provision of a "general and uniform" system of public education.

Goals, objectives, and standards must be established to carry out the Legislative mandate for public education. The designated state educational agency must assume responsibility for assuring a reasonably adequate level of programs and services throughout the state. Periodic review and updating must be incorporated into the process.

3. Each local school board should be given responsibility for establishing such goals, objectives, and standards as are necessary to meet the guidelines of the Legislature and the State Board of Education.

The philosophy is well established in Minnesota that most of the important educational decision-making rests with the local board of education. Maintenance of this division of authority in conjunction with Legislative and State Board of Education guidelines will satisfy the Constitutional mandate.

4. Provision should be made in each local school district for the training and retraining of selected personnel in utilization of the management system.

A system of education is only as good as the personnel involved in its actualization. The state must assure that such top and middle management personnel in each school district as school board members, school administrators, and department heads are trained in use of the management system.

5. A collecting and reporting system should be established which will provide information and data necessary for educational decision-making at all levels.

Decisions concerning education in the management system are dependent upon a comprehensive information and data base. This base can be established only if the anticipated outcomes of education are clearly defined and if assessment and evaluation capabilities are emphasized at both state and local levels. Local school districts and the State Department of Education should prepare annual reports concerning progress of education and the attainment of described goals and objectives. This information system should provide for "feed-back" at all involved educational levels and form the basis for operating a "general and uniform" system of education.

MANAGING THE MINNESOTA EDUCATION SYSTEM

Public elementary and secondary education in Minnesota is a \$1.6 billion annual business. Management of this business is a complex undertaking involving many people at many levels of government. With this complexity,

a systematic method of educational planning and implementation based upon a scientific technique of problem solving is necessary. A system must be created which is capable of translating our thoughts and wishes for education into practice.

THE EDUCATIONAL MANDATE

Article VIII, Section 1 of the Constitution of the State of Minnesota states:

"... it shall be the duty of the legislature to establish a general and uniform system of public schools."

In keeping with this mandate, the Legislature created the Department of Education and established a state network of public school districts. By 1947, this network had expanded to 7,606 separate and autonomous school districts. By 1974, this number has been reduced to 437 such districts each offering a program in grades K-12 or 1-12.

Each local school district was given responsibility for providing an educational program for children. The Department of Education developed some rules and regulations concerning this program but considerable discretion was left for the local district. As a result, substantial program differentials developed among the school districts. These differentials were clearly identified in Education 1967.

A fundamental problem is created when examining the Constitutional concept of "general and uniform." This is ambiguous terminology lacking in any clear direction for the public schools. The clause does imply, however, that the Legislature has ultimate responsibility for discharge of the Constitutional mandate, including provision for defining "general and uniform." The Legislature may delegate a certain amount of its responsibility to appropriate state and local agencies so long as there are adequate legislative guidelines. However, discharge of the "general and uniform" mandate is the responsibility of the Legislature no matter what other agencies and officers are involved.

DESCRIPTION OF A QUALITY EDUCATIONAL PROGRAM

Periodically, efforts are made to describe a quality educational program. One of the most extensive of these was the Department of Education sponsored study entitled Education 1967. This study examined all major facets of education and included recommendations for educational programming including an expansion of elementary school program and organization and a minimum of 30 course offerings in grades 7-12.

In Criteria Recommendations, the State Board of Education elaborated upon those recommendations. This document further refined the definition of adequacy for elementary, secondary, vocational, and special education. Most notable was a call for as many as 145 curricular offerings in grades 7-12.

The Governor's Task Force on Education for the 70's examined the matter of public school programming. While considerably less specific than the two earlier studies, this group also recommended improvement and addition to the public school program.

The earlier School Finance Task Force study also examined the public school program. After considerable deliberation, this group made several recommendations for extending and improving the school program.

These studies are but illustrative of more recent efforts at improving upon the public school program. They point out clearly, however, that "general and uniform" has neither been adequately defined nor fully implemented in this state.

ESTABLISHING GOALS, OBJECTIVES, AND STANDARDS

Increasingly numerous efforts are being exerted toward the generation of goals, objectives, and standards at the state and local levels. In the absence of a clear Legislative mandate, these efforts can only be fragmentary and inconclusive. What is required is a defined system for establishment of these vital ingredients to the educational process.

It is imperative that the public schools prepare young people in Minnesota to participate effectively as adults in a democratic society. It is equally important that the public schools provide students with sufficient skills to either pursue a course of post-secondary education or to compete successfully in the labor market upon leaving public school. The schools should supply students with enough knowledge of the workings of our economic system to serve them in the role of consumers. Finally, the schools should go beyond work-a-day concerns to broaden the horizons of students so that they may rewardingly and constructively use leisure time.

1. The Legislative Role

Since the Legislature is ultimately responsible for the operation of a "general and uniform" system of free public schools, it must give sufficient direction to state and local educational authorities to enable them to achieve this end. The Legislature must define the purpose of the educational system and delineate the philosophy which shall prevail. The generalized goals of public education must be enunciated and the responsibility for their attainment assigned to other components of the educational system.

2. The State Agency Role

As a designated agency of the Legislature, the State Board of Education must assume responsibility for more detailed goals and objectives which are applicable to every school district in the state and which are consistent with the more general Legislative goals. The State Board of Education must also periodically review and update the goals, objectives, and standards which they promulgate.

3. The Local Agency Role

Each local board of education should exercise the right, in accordance with rules established by the State Board of Education, to establish such goals, objectives, and standards as they desire.

These functional components must be consistent with the goals and guidelines of the Legislature and the State Board of Education. This local determination is consistent with the established philosophy of the state which places certain powers at the state level but leaves much of the important decision-making at the local level.

PROVISION FOR EVALUATION AND REPORTING

A major element in any educational management process is the continuing analysis or evaluation of the system. This analysis not only examines the educational processes which are involved but also stresses the assessment of educational outcomes and attainments. Information is disseminated to all component units of the educational system to assure a knowledgeable basis for decision-making.

At the State level, the Board of Education has responsibility for developing and administering a statewide system for assessing progress toward attainment of educational goals and objectives. Procedures are established for evaluating the effectiveness of programs and activities. A periodic report on the status of education should be prepared for submission to the Legislature.

Local school districts directly implement most components of the educational program. In facilitating the decision-making process, these districts have responsibility for reporting progress toward attainment of both State and locally determined goals and objectives. Fulfillment of this responsibility requires preparation of an annual report which includes:

- a. pertinent demographic data relating to each school,
- b. a facilities survey, including current use practices and projected capital project needs,
- c. results of assessment programs, including statewide and district testing conducted at each school,
- d. budgetary and cost data on each school's fiscal operation,
- e. an analysis of each school's relative progress in meeting State and district goals and objectives.
- f. plans for professional improvement,
- g. plans for innovative or experimental programs, and
- h. recommendations for school improvements during the ensuing year.

School district reports form the basis for reportage prepared by the State Department of Education. Increasing emphasis upon the type and quality of data in this reportage assures a better basis for decision-making. A "feed-back" loop is created which states the anticipated outcomes, reports attainments toward those outcomes, and provides support for the complete educational management system.

COMPONENTS OF THE MANAGEMENT SYSTEM

The educational management system must have flexibility to accommodate both general and specific application. Components of the system include:

- a. A statement of the major purpose of the organization.
- b. A definition of the expected outcome and identification of the factors essential to its attainment, i.e., diagnosis, prescription, dissemination of information, development of skills, testing, application, value judgments.
- c. Stated goals and objectives essential to the accomplishment of the purpose.
- d. A delineation of the methods for accomplishment -- a delivery system.
- e. A structure of organization inclusive of job descriptions and position relationships.
- f. A program oriented budgeting and accounting system.
- g. A data-based communication system which can facilitate management decision-making at all levels.

Finally, and by no means least, personnel at all levels must be trained to understand and use the management system. While all persons have need for this training, it is most imperative for persons in top and middle management positions.

APPENDIX C

MEMBERS OF THE BOARD OF DIRECTORS 1974

Mr. Robert Bigwood, Vice President
Otter Tail Power Company
215 South Cascade Street
Fergus Falls, Minnesota 56537

Mr. Thomas T. Dwight, Vice President
First Trust Company
W-555 First National Bank Building
St. Paul, Minnesota 55101

Mr. Kermit Eastman, Superintendent
St. Cloud Public Schools
13th Avenue and 7th Street South
St. Cloud, Minnesota 56301

Dr. Phillip Helland, Chancellor
State Board for Community Colleges
301 Capitol Square Building
550 Cedar Street
St. Paul, Minnesota 55101

Ms. Rosemary Hnilicka, Teacher
Resource Center, 9 Mile School
2201 West 108 Street
Bloomington, Minnesota 55431

Ms. Mary Jacobson, Past President
Minnesota Congress of Parents & Teachers
7515 Wentworth Avenue South
Richfield, Minnesota 55423

Mr. Ronald F. Kennedy, VP Public Affairs
Peavey Company
730 Second Avenue South
Minneapolis, Minnesota 55402

Mr. Robert S. Mars, General Manager, VP
W. P. & R. S. Mars Co.
215 South 27th Avenue West
Duluth, Minnesota 55806

Ms. Mary Ann McCoy
State President, League of Women Voters
2312 Lake Place
Minneapolis, Minnesota 55405

Mr. Howard P. Mold, Director
Management Center
College of St. Thomas
St. Paul, Minnesota 55105

Mr. Neil R. Morem, Vice President
Green Giant
5601 Green Valley Drive
Minneapolis, Minnesota 55437

Mr. Charles Nichols, Director
Vocational, Technical, & Industrial
Education
807 Northeast Broadway
Minneapolis, Minnesota 55413

Mr. Charles Nyberg, President, MACI
Vice President, George A. Hormel & Co.
P. O. Box 800
Austin, Minnesota 55912

Mr. Alan Ruvelson, Past President, MACI
First Midwest Corporation
1636 IDS Tower
Minneapolis, Minnesota 55402

Dr. Thomas Stark, Superintendent
Mankato Public Schools
West High School
51 Park Lane
Mankato, Minnesota 56001

Mr. Herbert Zaske
Board of Directors, MSBA
Farmer
Federal Crop Insurance Agent
R. R. 1
Brownton, Minnesota 55312

FOUNDATION FOR MINNESOTA PROGRESS
Hanover Building
480 Cedar Street
St. Paul, Minnesota 55101

FINANCIAL SPONSORS OF THE EDUCATIONAL PROJECT

Apogee Enterprises, Inc.	Hoerner Waldorf Corporation.
Cargill, Inc.	Honeywell, Inc.
Culligan Soft Water Service Company	George A. Hormel and Company
Electric Machinery Manufacturing Company	IBM Corporation
First Bank System, and	Investors Diversified Services, Inc.
First Edina National Bank	Lutheran Brotherhood
First Produce Bank, Minneapolis	Mankato Citizens Telephone Company
First National Bank, Alexandria	Robert S. Mars, Jr.
First National Bank, Austin	Minnesota Assn. of Commerce & Industry
First National Bank, Brainerd	Minnesota Natural Foundation
First State Bank, Ivanhoe	The 3M Company
First National Bank, Minneapolis	Minnesota Power & Light Company
First National Bank, Virginia	Northwestern Bell Telephone Company
First National Bank, Worthington	Ottertail Power Company
First Northtown National Bank	Owatonna Canning Company
First Security State Bank, St. Paul	Owatonna Tool Company
First State Bank, Benson	George M. Palmer Foundation
First State Bank, Paynesville	Peavey Company
First Midwest Corporation	The Pillsbury Company
H. B. Fuller Company	Rowell Laboratories, Inc.
General Mills, Inc.	The St. Paul Companies
Green Giant Foundation	Toltz, King, Duvall, Anderson & Associates, Inc.

FOUNDATION FOR MINNESOTA PROGRESS

Mailing address:
Hanover Building
480 Cedar Street
St. Paul, Minnesota 55101

Telephone contact:
Ron Kennedy
Foundation President
(612) 370-7611

Printing of this report contributed by H. B. Fuller Company.

Rationale of "The Future Management of Education"

Dr. Spencer W. Myers

December 1974

"Daniel Patrick Moynihan has recently said that further analysis proves James Coleman right in concluding in 1966 that school spending appears to have little to do with how well students learn."

Because "how well students learn" is the name of the game in education, the problem that faces education is multiple. Costs have greatly increased since World War II, though in recent years enrollments have been going down. One of the hopeful developments is the exploration of management systems for education, a series of techniques that are used extensively in other disciplines but have not had much impact on education to date.

A Management System

The major elements of management systems are the same for all types of organizations. They are

**Major Mission and \longrightarrow The Delivery System \longrightarrow The Result
Goals Establishment**

The production of learning should be considered the major mission of the education establishment. Consideration of goals can be made more effective if goals categories can be established, such as citizenship, careers and personal development. Supporting programs can then be identified, such as reading and arithmetic for citizenship purposes.

The delivery system, which produces the product, has the following elements: instructional materials, personnel, time, space, budget, organization structure, communications and appraisal. Instructional materials should be produced in a way that allows effective measurement of the amount of learning produced through their use. As the elements essential to the production of learning are identified, personnel should be specialized to those elements to a much greater degree than they are now. If individualization of instruction is a desirable process, then the kind of space furnished and the manipulation of time modules available should be directed to that end. Budget should be arranged so that the costs of producing programs and services are clearly identified. Financial assistance should be based on the programs and services offered.

Organization structure should be based on the careful development of a functional organization chart along with appropriate job descriptions. Objectives, consistent with the mission of the organization, should be required of all persons in the organization at six-month or yearly intervals. A communications system, preferably computer based, should be developed for two purposes:

1. Problem solving and decision making, and
2. Reporting the efficiency and effectiveness of the organization to all interested groups.

Appraisal is the process used for determining the efficiency and effectiveness of the delivery system.

The product is learning produced. Obviously, adequate measures of both quantity and quality are required.

What Can a Local Community Do?

1. The Board of Education, with the professional staff and appropriate committees representing the community, can establish goals for the school district. Every goal should be tested in the following way:

- a) Can it be programmed?
- b) Can results be measured?
- c) Can programs be costed?

2. As a requirement to meet No. 1, all board members, administrators and teacher leadership should be trained in goal setting. Management by Objectives is the most commonly known training mechanism for goal setting at the present time.

3. Accompanying Nos. 1 and 2, all administrators should be trained in the procedures for writing and field testing instructional objectives with related performance standards. (Criterion Reference Tests)

4. The district could identify locally a definition of learning for use in the district, along with an identification of the functions essential to its production.

5. Review current appraisal systems which relate to the efficiency and effectiveness of personnel with a view to giving learning production a maximum emphasis.

6. Reexamine the organizational structure of the school district with a view to abandoning functions not related to the established goals and objectives.

7. Examine program budgeting systems with a view to establishing a cost-effectiveness method of making priority judgments relating to programs and learning production.

8. Utilize computers where available to make facts more available for decision making and results reporting.

What Can the State Do?

Most states have a long tradition of local district autonomy in decision making relating to programs and services that the district will offer. Much can be said for this point of view because in this fashion decisions tend to be made closer to the need. However, there are some things that local districts cannot do well.

1. They cannot, or at least have not, developed for any state the major emphasis that the educational enterprise will consider primary, i.e. a commonly agreed upon major mission.

2. They cannot, or have not, agreed upon a commonly understood definition of learning or the functions essential to its production.

3. They cannot, or have not, developed a complete curriculum with accompanying performance standards. The development of such a curriculum would not in any way reduce local decision making. It would, however, make possible the eventual establishment of minimum performance standards for such basic citizenship subjects as reading.

The state can and should meet the above three needs. A state can also:

4. Act as effective repository of forward looking practices and innovative programs.

5. Agree upon a common method of budget change, i.e. program budgeting.

6. Determine that state support shall be paid on a programs and services basis.

7. Establish a language compatible computer system for the state so that records could be comparable.

It is the opinion of the author that

1. The state, i.e. some combination of legislature, state board and state department should establish the major mission of the educational enterprise in the state.

2. A common definition of learning and the functions essential to its production would be of benefit to the state.

3. The total curriculum based on instructional objectives and performance standards would make more instructional materials available to students and teachers than have ever been available before.

4. Budgeting on a program and service basis and state support on the same basis would make possible cost-effectiveness judgments that are not possible now.

5. A compatible computer system would be of major advantage to the educational organizations in the state.

If, as all legal decisions indicate, education is a state function, it would be greatly advantageous if the above functions were performed by the state with the cooperation and advice of the local districts. This could be done without major loss of decision making on the part of the local districts and with major gains for the students of the state.

After all, isn't that the measure?

FOUNDATION FOR MINNESOTA PROGRESS
Hanover Building
480 Cedar Street
St. Paul, MN 55101